



R470

Description

To use heating energy only where and when it is actually needed, the most simple, cheap and reliable independent thermoregulation solution is to equip each radiator in the building with valves with thermostatic option and thermostatic heads.

Thermostatic heads serve to keep constant the ambient temperature of the room in which they are present, according to the set value.

The **R470** thermostatic head is equipped with liquid sensor and Clip-Clap quick connection to the valve body.

Versions and product codes

Series	Product code	Connection
R470	R470X001	Clip-Clap

Technical data

- Can be installed on all valves with thermostatic option, series TG, D, F
- Temperature range in combination with the valve bodies: 5÷110 °C
- Max. working pressure in combination with the valve bodies: 10 bar
- Max. differential pressure in the valve: 1,4 bar (3/8", 1/2"); 0,7 bar (3/4")
- Min. head calibration: 8 °C in position *
- Max. head calibration: 32 °C in position *

Valve size	Nominal flow rate q_{mNH} [kg/h]	Authority "a" of the stopper
3/8" - 1/2" (R401TG, R402TG, R403TG, R415TG, R435TG, R421TG, R422TG, R401D, R402D)	150	0,83
3/4" (R401D, R402D, R401F, R402F, R421F, R422F)	240	0,79

i The declared values refer to the installation condition of the thermostatic head on the Giacomini valve bodies of the TG, D, F series.

Hydraulic features

The data shown are obtained according to the specifications of the EN215 Standard.

• **R470 in combination with the valve bodies 3/8" - 1/2"** (R401TG, R402TG, R403TG, R415TG, R435TG, R421TG, R422TG, R401D, R402D)

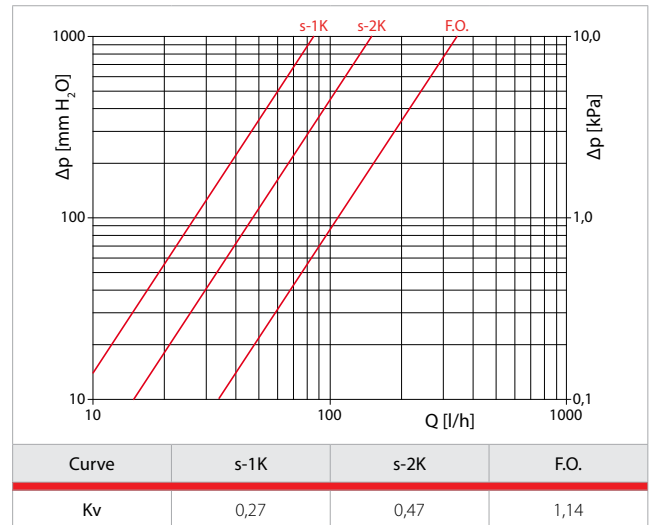

• **R470 in combination with the valve bodies 3/4"** (R401D, R402D, R401F, R402F, R421F, R422F)

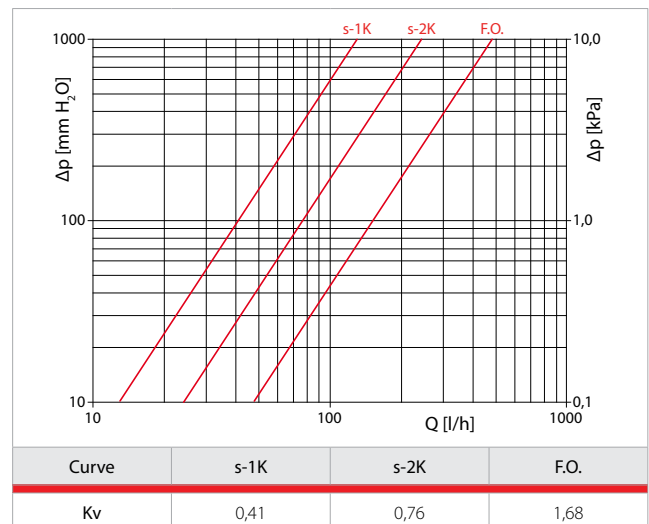

Operation

The temperature variation of the environment causes a consequent variation in the volume of the liquid contained in the sensor inside the head.

This volume change causes the movement of an internal mechanism with the consequent closing or opening of the valve and therefore with modulation of the flow of water that enters the heating element.

When the temperature in the room is approaching the required value, the head gradually closes the valve, letting through just the minimum amount of water needed to keep the room temperature constant; this means guaranteed energy savings.

KEYMARK (EN215) certification

Product code	Declared hysteresis "C"	Influence of the declared water temperature "W"	Declared response time "Z"	Influence of the declared differential pressure "D"
R470X001	0,40 K	1,20 K	26 min.	0,55 K

Installation

• Thermostatic heads must be installed in the horizontal position.



⚠ These positions are not recommended due to the influence of the radiator temperature on the thermostatic head.

• In order to prevent inaccurate temperature detections, thermostatic heads should not be installed in recesses, in curtain boxes or behind curtains, and should not be exposed to direct sunlight. In these cases it is advisable to use the models with remote sensor (R462 / R463).

• To install the thermostatic heads on the valve body, proceed as follows:



1) Fully open the head by turning the knob to position *****. Next, pull the Clip-Clap connection towards the knob.



2) Connect the thermostatic head to the valve, making sure the valve pin (A), the small slot on the thermostatic head (B) and the indicator line (C) are aligned.

⚠ Warning.
The correct slot for assembly is the smallest one. Do not try to install using the largest slots.



3) Fully close the head by turning the knob (turn the knob to position *****).



4) The head is now installed to the valve and can be moved to the required adjustment position by turning the knob.

Adjusting the temperature

The correct adjustment position for thermostatic heads is obtained by referring to the following table, which matches the numbering on the knob to the corresponding room temperatures.

Position	*	1	2	3	4	5	*
Temperature adjusted [°C]	8	10	15	20	25	30	32



Note.

The values shown in the table refer to the optimum conditions obtained in a climatic chamber. In the room itself, these values may be altered by factors such as the type of installation, the environmental conditions, the degree of insulation in the building, and the characteristics of the radiators.

If the radiator is positioned where there is cold air or draughts, the calibration temperature will not correspond to the average room temperature because the head sensor is influenced by the local temperature and therefore commands the closure of the valve too early or not at all. In these cases, the knob must be repositioned with the aid of a mercury thermometer positioned in the middle of the room.

In example: if the head is in position 3 and the room temperature is lower than the 20 °C envisaged while the system is working, this means the valve has been prematurely closed due to local excess temperature. In this case, turn the knob slightly until it is halfway between number 3 and number 4. Vice versa, if the temperature is higher than the 20 °C when the head is in position 3, this means the it is positioned in a cold draught and therefore keeps the valve open. In this case, turn the knob until it is halfway between number 2 and number 3.

If the thermostatic head is installed in rooms that are not in use, you can ensure the best energy savings by turning the knob to position ***** (corresponding to the 8 °C anti-freeze protection temperature).



Warning.

To avoid excessive loads on the seal gasket of the thermostatic bonnet (with the resulting risk of jamming and locking) during the summer months, is recommended to place the knob in the fully open position, as marked by the symbol *****.

Knob opening limit / locking

The knob limit and locking operations are carried out with the thermostatic head already installed on the valve body.



1) Turn the knob to position (3) and release it by pulling it forward.

⚠ Warning.

In order to prevent losses in calibration of the thermostatic head, never tamper with the position of the bulb for any reason.

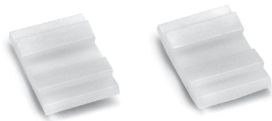

2) Use one of the limiters included in the box to achieve partial opening or closure of the thermostatic head. By using both limiters, you can fix the upper and lower limits of the adjustment range, in order to lock the thermostatic head at the required position.

3a) A **partial opening** of the thermostatic head can be achieved by inserting the limiter into the cam (referring to the photo):



• on the right of the number corresponding to the maximum desired opening.
Example: fix the limiter to the right of the number 3. In this way, is possible to fully close the head, or open up to 3).



• on the left of the number corresponding to the minimum desired opening.
Example: fix the limiter to the right of the number 3. In this way, is possible to fully close the head, or open up to 3).



3b) In order to **lock** the adjustment range, position a limiter to the right of the number corresponding to the maximum desired opening and a limiter to the left of the number corresponding to the minimum desired opening. This prevents the head from being either opened or closed.



4) After the limiters have been positioned, return the knob to the initial adjustment position (3), applying sufficient pressure.



i Note.

On looking inside the head, near the bulb, a black mark should be visible. Check that this mark is always in line with the Keymark symbol on the separator.

Dimensions

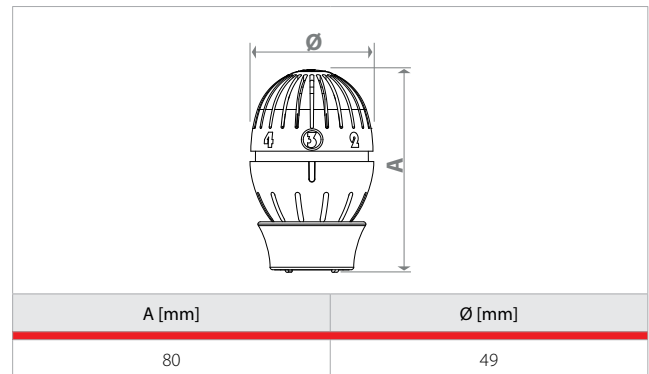

Product specifications

R470

Thermostatic head with liquid sensor and Clip-Clap quick connection. Adjustment positions from * to ✱, corresponding to a temperature range of 8÷32 °C. Possibility to block or achieve partial opening and/or closure via the limiters supplied. Can be installed on all valves with thermostatic option, series TG, D, F. Temperature range combined with valve bodies 5÷110 °C. Max. working pressure in combination with the valve bodies 10 bar. KEYMARK (EN215) certification.

THERMOSTATIC HEADS

0112EN March 2018

THERMOSTATIC HEAD WITH LIQUID SENSOR
CLIP-CLAP QUICK CONNECTION
R470



GIACOMINI
WATER E-MOTION

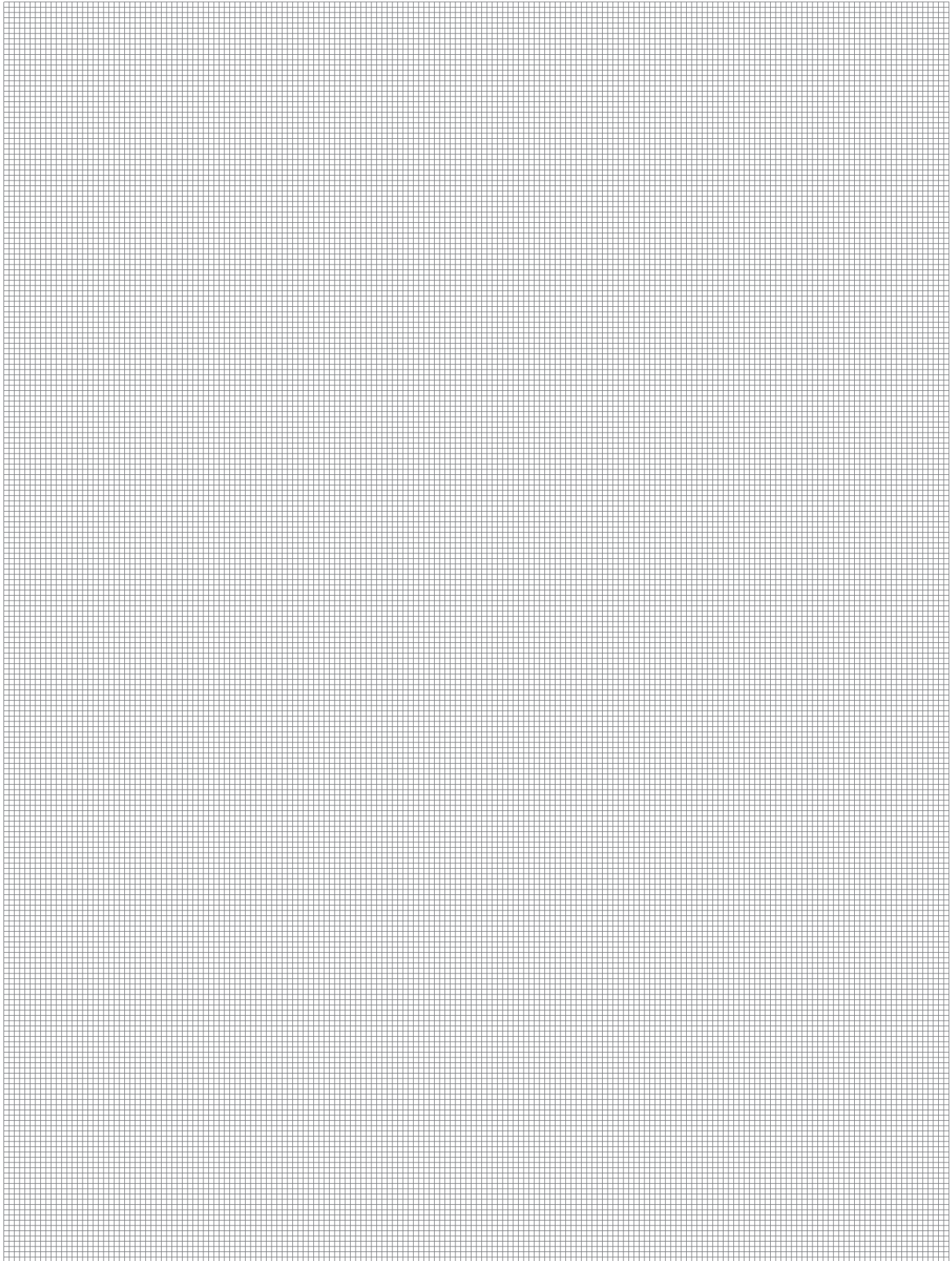

Additional information

For more information, go to www.giacomini.com or contact our technical assistance service: ☎ +39 0322 923372 📠 +39 0322 923255 ✉ consulenza.prodotti@giacomini.com
This document provides only general indications. Giacomini S.p.A. may change at any time, without notice and for technical or commercial reasons, the items included herewith.
The information included in this technical sheet do not exempt the user from strictly complying with the rules and good practice standards in force.
Giacomini S.p.A. Via per Alzo, 39 - 28017 San Maurizio d'Opaglio (NO) Italy