



# NEXUS

---

Flow of Innovation

## **INSTALLATION-OPERATION-MAINTENANCE**

---

*Effective Date: August 20, 2021*

***Please read and follow instructions within. Disregarding these instructions may result in poor performance and / or product failure and void your warranty.***

**Nexus Valve, Inc.**

---

Tel 888.900.0947  
Fax 800.900.8654

9982 E. 121st Street  
Fishers, IN 46037

[www.nexusvalve.com](http://www.nexusvalve.com)  
[info@nexusvalve.com](mailto:info@nexusvalve.com)



# Table of Contents

- Limited Warranty.....1
- General Information..... 1
- UltraMatic™ ..... 11
- Dynamic™ ..... 18
- UltraXB™ Orturi..... 23
- UltraMB™ ..... 26
- Nextrol™..... 33
- UltraMBF™ ..... 37
- Nexus Venturi – Model NV™..... 43
- Strainex™ ..... 46
- UltraY™ ..... 48
- UltraX™ ..... 51
- UltraNXP™ ..... 52
- UltraU™ ..... 53
- Valves for Actuators (UMA / MBA) ..... 54
- Ultra BK™ Bypass Kits ..... 58
- UltraT™ ..... 60
- Configur-A-Ball ..... 61
- NXU / NXS / NXH ..... 62
- UltraFlex™ ..... 63
- Meter Kits – MKA..... 68
- Meter Kits – MKM ..... 69
- Manual Air Vents..... 70
- Handle Extension Kits ..... 71
- Extension PTE / PTEB ..... 72
- Union Adapter ..... 73
- Tool Requirements..... 74
- Replacement O-Rings..... 75
- Replacement Gaskets ..... 76
- Notes..... 77



# Installation - Operation - Maintenance

**Nexus Valve, Inc.**  
9982 E. 121<sup>st</sup> Street  
Fishers, IN 46037  
(888) 900-0947 (800) 900-8654 Fax  
info@nexusvalve.com www.nexusvalve.com

**Effective Date:** August 20, 2021

All goods sold hereunder are warranted to be free from defects in material and factory workmanship for the applicable Warranty Period. Various other products supplied through Nexus from an other manufacturer, such as temperature control valves, shall be subject to that manufacturers' warranty. Any misapplication, tampering, adjusting, abuse or other changes in the field to Nexus products will result in the automatic voiding of the Nexus limited warranty.

### Replacement Parts

Nexus will replace or repair any of its valves, unions, or accessories which is determined to be defective in workmanship or material, free of charge, provided such products are installed in accordance with the best practices accepted in the trade and recommended in the Nexus Valve I.O.M.

### Liability

THE LIABILITY OF NEXUS IS LIMITED TO REPLACEMENT OR REPAIR OF THE DEFECTIVE PART WHICH MUST BE RETURNED TO NEXUS WITH WRITTEN NOTICE BEFORE SUCH REPLACEMENT OR REPAIR IS MADE. NEXUS IS NOT LIABLE FOR INCIDENTAL OR CONSEQUENTIAL DAMAGES, INCLUDING BUT NOT LIMITED TO LOSS OF PROFIT, EXPENSES OF DELAYS, AND LOST SERVICE TIME.

### Exclusions

This warranty applies only to defects in workmanship or material. The warranty does not include threaded connections, union connections, press or push connections, O-rings, gaskets, field connections, or products subject to conditions beyond those specified for the products. This warranty is in lieu of all other warranties, whether expressed or implied.

### WARRANTY PERIOD

BRAND	PRODUCT GROUP	WARRANTY PERIOD
Nexus	Nexus Valve	5 Years from Date of Purchase
	Efficiency & Safety	5 Years from Date of Purchase
	Pressurization & Storage	5 Years from Date of Purchase
	Vacuum Deaeration	2 Years from Date of Purchase
Various	Various	Subject to OEM Warranty. Contact Nexus for details.



**Nexus Valve, Inc.**  
9982 E. 121<sup>st</sup> Street  
Fishers, IN 46037  
(888) 900-0947 (800) 900-8654 Fax  
info@nexusvalve.com www.nexusvalve.com

**Effective Date:** August 20, 2021

---

## GENERAL INFORMATION

---

### General Information

#### Symbology



Important Information Please Review



Reference To Alternate Page



Unacceptable Installation  
Do Not Violate This Information



Acceptable Installation

#### Threaded Connections

Threaded connections in the field should be made according to specified or industry-accepted standards. All tapered pipe thread connections of Nexus Valve products conform to the ANSI/ASME B1.20.1-1983 American National Standard for Taper Pipe Threads (NPT threads).

When installing valve bodies with a threaded connection, it is imperative to use the flats provided on the threaded connection to resist the torque required for tightening the mating pipe threads. **DO NOT OVER TIGHTEN THREADED CONNECTIONS.**

#### **DO NOT PLACE WRENCH / TOOL ON VALVE BODY!**

The threads provided on Nexus Valve union connections are straight threads with no taper, conform to the ANSI/ASME B1.20.7-1991 American National Standard for Hose Coupling Threads (NPSH threads), and require an o-ring or gasket per design to seal.

Piping connections to a union tail piece must only be made while the tail piece is disconnected from the union. The union connection can be reassembled after the tail piece piping connection is completed.

Factory installed accessories (PT test plugs, MV air vents, PG plugs, BD drain valves, etc). are sealed at the factory and should not be disturbed after delivery.

#### Sweat Connections

Nexus Valve products with sweat connections are intended for "soft" solders with low melting temperatures. They are not designed for "silver" solders or other high temperature soldering methods. Use a standard approved soldering procedure including proper preparation of the copper pipe and cleaning of the pipe, valve connection, and/or union tail piece fitting.

**AVOID OVERHEATING THE VALVE OR OTHER COMPONENTS WHEN MAKING SWEAT CONNECTIONS!  
A HEAT SINK - SUCH AS A WET RAG - MUST BE USED WHEN MAKING SWEAT CONNECTIONS!**



# Installation - Operation - Maintenance

**Nexus Valve, Inc.**  
9982 E. 121<sup>st</sup> Street  
Fishers, IN 46037  
(888) 900-0947 (800) 900-8654 Fax  
info@nexusvalve.com www.nexusvalve.com

**Effective Date:** August 20, 2021

---

## GENERAL INFORMATION

---

For valve bodies with integral sweat fittings, special care must be taken to avoid overheating the seals, o-rings, and sealant used in the valve body assembly. Position the valve lever or handle in the open position to eliminate pressure buildup and dissipate heat and use a heat sinking method.

**FAILURE TO PROTECT THE VALVE BODY AND SEALS CONTAINED WITHIN THE VALVE BODY FROM OVERHEATING WILL CAUSE THE SEALS TO FAIL, THE VALVE TO LEAK, AND WILL VOID THE NEXUS VALVE WARRANTY.**

For valve and/or union bodies with a sweat type union end tail piece, the tail piece must be removed from the valve or union body before heat is applied to avoid damaging the union o-ring.

### NexPress™ Connections

The NexPress™ connection is for use with Types K, L, and M hard copper tubing. The maximum working pressure on the NexPress™ fitting is 200 psi and is manufactured for water and water/glycol systems. For the connection to work “leak free” it is mandatory that the end of the copper tube be properly “dressed.” Failure to “dress” the tube properly will result in a torn or damaged o-ring and result in a weak or leaking seal. To properly use NexPress™ fittings:

- We recommend not using pipe fittings that do not have the required length of straight pipe. If using pipe fittings, be sure to properly dress them.
- Cut the end of the tube square.
- Remove all dirt, debris & burrs inside and outside.
- Chamfer the leading edge of the tube 5mm by 30 degrees.
- Ensure that the o-ring is present in the fitting, check that the o-ring is positioned evenly in the fitting’s groove and is free of dirt, oil or other foreign materials.
- Insert tubing into the fitting, ensure that the tubing inserts fully into the fitting.
- If the tubing is difficult to insert, a little water or a food grade silicone spray may be applied to the tubing.
- Once the tubing is fully inserted, the fitting must be crimped using crimping tools, Ridgid ProPress, Stanley, NIBCO, etc.
- A minimum distance between press fittings must be ½ the tubing diameter.
- Consider clearance requirements between wall/ceiling & piping for the press tool.
- When transitioning to threaded connections, the threaded connection is made first.
- A minimum distance, when pressing a connection near an existing brazed fitting, of 2x the tubing diameters is required.
- A minimum distance, when pressing a connection near an existing solder fitting, of ½ the tubing diameters is required.
- When soldering near a NexPress™ connection a minimum distance of 3x tube diameters is required.
- When brazing near a NexPress™ connection a minimum distance of 9x tube diameters is required.
- A minimum distance of 4” must be maintained when welding a pipe adjacent to a pipe with a NexPress™ connection.
- A minimum distance of 3’ must be maintained when welding on the same pipe as a NexPress™ connection.

**Nexus Valve, Inc.**  
 9982 E. 121<sup>st</sup> Street  
 Fishers, IN 46037  
 (888) 900-0947 (800) 900-8654 Fax  
 info@nexusvalve.com www.nexusvalve.com

**Effective Date:** August 20, 2021

## GENERAL INFORMATION

- A minimum distance of 4” must be maintained when attaching a sliding pipe hanger to a pipe with a NexPress™ connection.
- Pressure surges that result in water hammer effects can cause damage to the press fittings.
- Pressing causes pipe deflection. To minimize this, alternate the position of the press tool on each fitting connection in a piping line.
- After crimping, inspect and mark that the fitting has been crimped. Check for leaks.

Tube Size (Inch)	Required Insertion Depth (Inches)
1/2”	13/16”
3/4”	1”
1”	1”
1 1/4”	1”
1 1/2”	1 7/16”
2”	1 5/8”

### NexLok™ Connections

NexLok™ and NexLok™ LD connections are for use with ASTM B88 hard drawn and annealed Type K,L, and M copper tubing 1/2” through 2” and with 1/2” through 2” PEX tubing with a Nexus Tube Liner. The NexLok™ fitting is designed for 1/2 “ to 1“ tubing and is rated for temperatures of 0°F to 200°F with a maximum working pressure of 250 PSI. The NexLok™ LD is designed for 1-1/4” through 2” tubing and is rated for temperatures of 0°F to 200°F with a maximum working pressure of 200 PSI. Both the NexLok™ and The NexLok™ LD are manufactured for water and water/glycol systems.

For the connection to work properly it is mandatory that the following instructions be followed:

- We recommend not using pipe fittings that do not have the required length of straight pipe. If using pipe fittings, be sure to properly dress them.
- The NexLok™ fittings must not come in contact with household or industrial cleaning products, paints, greases, fluxes, mineral oils, adhesives, nitrates or other solvents during installation or after installation.
- The exterior surface of the NexLok™ fitting should not be painted.
- All proprietary flushing chemical should be reviewed with Nexus engineering prior to use.
- Soldering or brazing should not be done within 12” of the NexLok™ fitting.
- All soldered or brazed piping systems must be cool to touch before insertion into the NexLok™ fitting.
- When transitioning to threaded connections, the threaded connection should be made first.
- All TCV’s should be atleast 5 tubing diameters from each NexLok™ fitting.

**Nexus Valve, Inc.**  
 9982 E. 121<sup>st</sup> Street  
 Fishers, IN 46037  
 (888) 900-0947 (800) 900-8654 Fax  
 info@nexusvalve.com www.nexusvalve.com

**Effective Date:** August 20, 2021

## GENERAL INFORMATION

Installation of 1/2" through 2" tube:

- Cut the tube square (perpendicular to centerline of tube) with a tube cutter
- Remove burrs by chamfering the inside and outside diameters of the tube
- Mark the required insertion depth of the tube (See table below – following page).

Tube Size (Inch)	Required Insertion Depth (Inches)
1/2"	15/16"
3/4"	1 1/8"
1"	1 5/16"
1 1/4"	2 1/4"
1 1/2"	2 7/16"
2"	2 3/4"

- A Nexus Tube liner / PEX insertion sleeve must be inserted into the PEX tubing before inserting into the NexLok™ connection.
- Holding the fitting firmly, insert the tube straight into the fitting with a twisting motion until the depth mark on the tube is aligned with the end of the fitting.
- Check that the depth mark is at the end of the fitting, if not, continue to push the tube to the full insertion depth.
- A minimum distance between press connections, after full insertion depth, should be 1".
- Once the tube is correctly installed to the proper depth, limit rotation of the tube.



Inserting a properly prepared tube straight into the NexLok™ fitting will produce a leak free joint, will reduce insertion force, will prevent o-ring damage, and will insure the tube may easily be inserted to the proper depth. Failure to properly prepare the tube, inserting at angle and pulling the tube into proper alignment with the fitting is poor assembly practice and may result in a leaking joint.



**DO NOT** insert anything into the NexLok™ grab ring fitting other than water tubing; it may not release. This warning includes human body parts and is critical to your health and safety. Seek emergency medical services if you become entangled in the grab ring mechanism inside the NexLok™ fitting.

Removal of the tube from the NexLok™ fitting:

- Select the correct size removal tool for the job;
- Place the removal tool around the tube next to the fitting assembly. The flat side of the tool should be placed in contact with the fitting.
- Push the removal tool toward the fitting firmly until the grab ring is compressed.
- With the removal tool firmly held in place, use a twisting, and pulling motion to remove the tube from the fitting.
- Release the removal tool after the tube is removed.

**Nexus Valve, Inc.**9982 E. 121<sup>st</sup> Street

Fishers, IN 46037

(888) 900-0947 (800) 900-8654 Fax

info@nexusvalve.com www.nexusvalve.com

**Effective Date:** August 20, 2021

## GENERAL INFORMATION

- If the tube is to be re-used, check the tube for score marks, and any other defects such as dirt, or chips.
- If any defects exist, the tube must be repaired as needed to meet the installation requirements detailed previously in this installation manual.
- Check the internal parts of the fitting. The grab ring, pipe guide, and o-ring must be in the housing and aligned with the fitting opening.
- If all of the parts are in good condition, and aligned, then the fitting is ready to be assembled with a properly prepared pipe or tube.

### Removal of the tube from the NexLok™ LD fitting:

- Ensure water pressure is removed from piping and the piping section isolated.
- Using a the adjustable spanner wrench from Nexus, place the wrench tangs in the opposing slots in the end cap and loose the end cap by turning wrench counter clock-wise (Fig 1).
- Pull the end cap away from the fitting.
- Remove the pipe and the grip ring from the fitting.
- Use an acceptable tool and cut the grip ring from the pipe. Care should be taken with the grip ring to avoid injury.
- Ensure the o-ring and protection ring are seated into the fitting – if not well seated ensure reassembly in the same sequence as removed from the fitting.
- Place a NEW grip ring, available from NEXUS into the fitting. Ensure seating against the protection ring. Ensure the grip ring seats with the taper facing inward toward the o-ring.
- Re-inert end cap and tighten into the fitting until snug – the fitting is ready for tube inserting. Be sure to follow instruction above for preparing the tube for insertion.



Figure 1

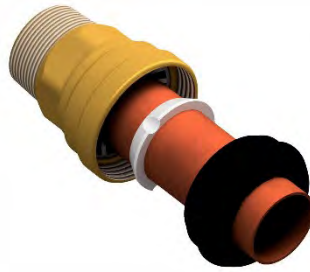

Figure 2

### Removal of tube from the NexLok™ using demount rings

- Using a the adjustable spanner wrench from Nexus, place the wrench tangs in the opposing slots in the end cap and loose the end cap by turning wrench counter clock-wise (Fig 1).
- Slide the cap away from the fixed end on the pipe.
- Take the appropriate sized demount ring provided by Nexus, and snap it over the pipe between the cap and grip ring (Fig 2).
- Ensure the tapered end of the demount ring is facing the grip ring.
- Guide the cap back onto the fixed end and hand tighten.



**Nexus Valve, Inc.**  
9982 E. 121<sup>st</sup> Street  
Fishers, IN 46037  
(888) 900-0947 (800) 900-8654 Fax  
info@nexusvalve.com www.nexusvalve.com

**Effective Date:** August 20, 2021

---

## GENERAL INFORMATION

---

- Twist and pull the pipe from the fixed end; unscrew the cap and remove the demount ring.

### Union Tail Piece Installation

Nexus Valve manufactures a series of interchangeable union end tail pieces for 1/2" through 2-1/2" connections.

#### Preparing for Installation of Union Tail Pieces

For both threaded and sweat types of tail pieces, the union tail piece must be disassembled from the valve or union body for the installation procedure. Separate the union tail piece from the valve body by removing the union nut, taking care not to lose or damage the union o-ring. Care must also be taken not to damage the o-ring sealing surface of the tail piece during handling and the installation procedure. This surface must not be scratched, deformed, or otherwise damaged in any way if the union o-ring seal is to perform properly.

#### Installation of Threaded Union Tail Pieces

Refer to instructions on [Preparing for Installation of Union Tail Pieces](#) before proceeding.

Position the union nut on the pipe side of the tail piece connection prior to installing the tail piece on the pipe, so that the union nut is available to reassemble the union connection.

Threaded tail pieces should be held properly during the thread tightening process. It is critical that the internal hex keyway or external tool flats provided on the tail piece be used to resist the torque required for tightening.

Nexus Valve threaded tail pieces for 1/2" through 1" NPT connections have an internal (female) hex keyway to facilitate installation. For these tail pieces, the proper hex key size for each NPT connection size is given on page 74. Nexus Valve offers a tool kit that includes the appropriate hex keys.

For valves equipped with 1-1/4" through 2" NPT threaded tail pieces, use the provided flats around the circumference of the fitting to hold and tighten the tail piece.

If necessary, apply pipe sealant to pipe threads per industry standard practice. Note that Nexus Valve supplies some male thread components with pre-applied Loctite® sealant; while found to be an effective timesaver, this provision is a convenience feature only and the performance of this sealant is not warranted.

Tighten the tail piece per industry standard practice and proceed to [Completing the Installation of Union End Tail Pieces](#).

#### Installation of Sweat Union Tail Pieces

Refer to instructions on [Preparing for Installation of Union Tail Pieces](#) before proceeding. Union tail pieces with a sweat type connection must be disassembled from the valve or union body before making the soldered connection. Separating the union tail piece from the valve or union body allows the soldering procedure to be done without overheating and damaging the o-ring seal of the union connection.

Position the union nut on the pipe side of the tail piece connection prior to installing the tail piece on the pipe, so that the union nut is available to reassemble the union connection.

**Nexus Valve, Inc.**  
 9982 E. 121<sup>st</sup> Street  
 Fishers, IN 46037  
 (888) 900-0947 (800) 900-8654 Fax  
 info@nexusvalve.com www.nexusvalve.com

**Effective Date:** August 20, 2021

## GENERAL INFORMATION

Perform the soldering procedure in accordance with industry standard practice while adhering to the guidelines in Section II, Sweat Connections on page 2.



**Allow the soldered connection to cool to ambient temperature before proceeding! Attempting to reassemble the union connection before allowing the soldered piece to cool will damage the union o-ring.**

Proceed to Completing the Installation of Union End Tail Pieces.

### Completing the Installation of Union Tail Pieces

After following the proper installation procedures for installation of the union end tail piece and the associated valve or union body, the union connection with o-ring may be reassembled. Follow the installation and assembly instructions on page 8 named, Union O-Ring Installation & Union Assembly.

### Union O-Ring Installation & Union Assembly

An o-ring seal is a dynamic seal in that it is intended to move within the o-ring groove or gland. The o-ring groove is purposely designed wider than the o-ring width - per design standards for o-ring sealing applications so that the o-ring may move to seal the leak path when pressure is applied.

### PIPE DOPE OR SEALANT SHOULD NEVER BE APPLIED TO THE O-RING, O-RING GROOVE, OR MATING SURFACE.

Inspect the o-ring groove for damage or debris (including pipe sealant). Inspect the mating surface of the tail piece flange to insure that it is not scratched, deformed or otherwise damaged. Any damaged components must be replaced.

Carefully place the o-ring in the groove. Use of a quality non-petroleum based o-ring lubricant at the time of installation will help protect the O-ring from damage by abrasion, pinching, rolling or cutting and facilitate installation. Confirm that the o-ring is properly placed in the groove and reassemble the union connection. Secure the union nut hand-tight, **and then tighten no more than an additional ¼ turn.**

### Flanged Product Bolting Specifications

Field supplied studs, nuts and bolts should meet the following specifications:

- Carbon Steel
- ASME A307 Grade B material requirements
- ASME B18.2.1 Square Head Bolt or Heavy Hex Head Bolt requirements
- ASME B18.2.2 Heavy Hex Nut requirements

Recommended torque for tightening nut and bolt.	Bolt Size	Torque ft-lb
	5/8"	84
	3/4"	105
	7/8"	160
1st Round - 30% of final torque 2nd Round - 60% of final torque 3rd Round - 100% of final torque One final time clockwise around flange		

**Nexus Valve, Inc.**  
 9982 E. 121<sup>st</sup> Street  
 Fishers, IN 46037  
 (888) 900-0947 (800) 900-8654 Fax  
 info@nexusvalve.com www.nexusvalve.com

**Effective Date:** August 20, 2021

## GENERAL INFORMATION

**4 Bolt Star Pattern  
Tightening Sequence**

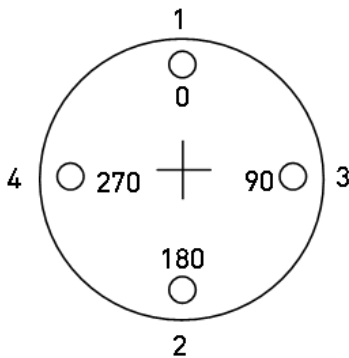

**8 Bolt Star Pattern  
Tightening Sequence**

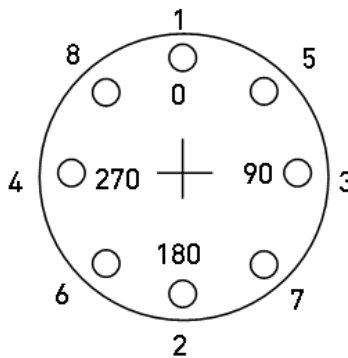

**12 Bolt Star Pattern  
Tightening Sequence**

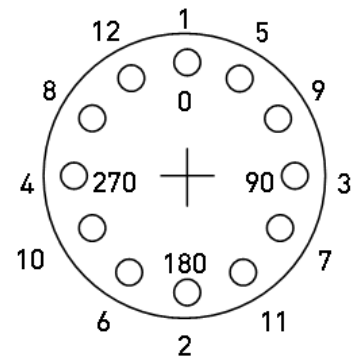

### NPT Accessory Installation Procedure

Most products come assembled to factory specifications. Accessories on valves larger than 2-1/2" do not come assembled. Nexus Valve recommends tightening accessories to the following torque specifications:

- Accessories used in the 1/4" NPT to 13 - 15ft-lb.
- Accessories used in the 1/2" NPT to 20 - 25 ft-lb.
- Accessories used in the 3/4" NPT to 23 - 30 ft-lb.
- Thread sealant is pre-applied on most Nexus Valve supplied accessory MNPT connections.

### Valve Identification

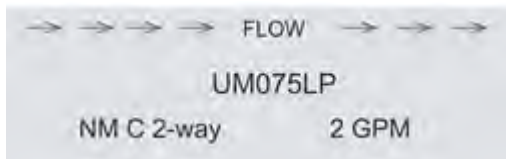

UM and UMS valves are shipped with a standard body identification tag located on the top of the handle or body. This tag includes the following information: flow rate (GPM), valve size, direction of flow, and location information (if provided). An optional hanging tag is also available.



Wafer style UltraMatic™ valves are shipped with a standard body identification tag located on the valve body. This tag includes the following information: model number, control range (PSID) & flow rate (GPM).

**Nexus Valve, Inc.**  
9982 E. 121<sup>st</sup> Street  
Fishers, IN 46037  
(888) 900-0947 (800) 900-8654 Fax  
info@nexusvalve.com www.nexusvalve.com

**Effective Date:** August 20, 2021

## GENERAL INFORMATION



UltraXB™ Orturi valves are shipped with a tag on the handle as well as a body marking. This tag will indicate which modified venturi tube has been installed in the valve.

### Standard Hanging Tag



For all valve products, an optional hanging body tag is available. This tag includes the part number and upon customer request, a tagging location.

### Nextrol™ Hanging Tag



Nextrol™ products are shipped with a hanging tag. This tag includes model number, valve size, and tag location

**Nexus Valve, Inc.**  
9982 E. 121<sup>st</sup> Street  
Fishers, IN 46037  
(888) 900-0947 (800) 900-8654 Fax  
info@nexusvalve.com www.nexusvalve.com

**Effective Date:** August 20, 2021

---

## ULTRAMATIC™

---

### UltraMatic™

UltraMatic™ is a pressure independent automatic flow limiting valve. The UltraMatic™ is available in several sizes and configurations.

#### General Information

- UltraMatic™ can be installed in horizontal and vertical planes.
- When installing UltraMatic™, space around the valve must be provided for port access and rotation of the handle.
- Each UltraMatic™ has an internal cartridge that is factory-set to a specific flow rate (GPM). This flow rate cannot be adjusted in the field. Contact your local Nexus Valve representative if a different GPM is required. See page 16 for instructions to replace the cartridge if this becomes necessary.
- It is imperative that the valve be installed with correct direction of flow.
- Installation of a y-strainer is recommended upstream for any control valve or balancing device.



To achieve maximum performance, the elimination of air in the fluid is required.



Do not back flush with the cartridge in the body. Nexus Valve recommends using an UltraBK™ Series bypass and flushing kit for flushing the hydronic system prior to start up and after periodic maintenance.



Refer to page 2 for installation procedure.  
Refer to page 10 for valve identification

### UltraMatic™ Model UM

The UltraMatic™ Model UM is a pressure independent automatic flow control valve (AFCV) which has both an isolation ball valve and union integrated into one body. In various configurations, the Model UM can accommodate several types of accessories, but comes standard with two pressure and temperature test plugs.

#### Straight Run Requirements

UltraMatic™ does not typically require any straight pipe runs up or downstream. Changes in pipe diameter size at the valve inlet may cause turbulence impacting pressure drop readings.

#### Accessory Port Locations

UltraMatic™ comes equipped with two (2) PT test plugs. Standard configuration will have the port # 2 designated for high-pressure and port # 1 for low-pressure. Other configurations are available, contact your representative for assistance. (See images on next page for additional reference).

**Nexus Valve, Inc.**  
 9982 E. 121<sup>st</sup> Street  
 Fishers, IN 46037  
 (888) 900-0947 (800) 900-8654 Fax  
 info@nexusvalve.com www.nexusvalve.com

**Effective Date:** August 20, 2021

## ULTRAMATIC™

### Standard Configuration

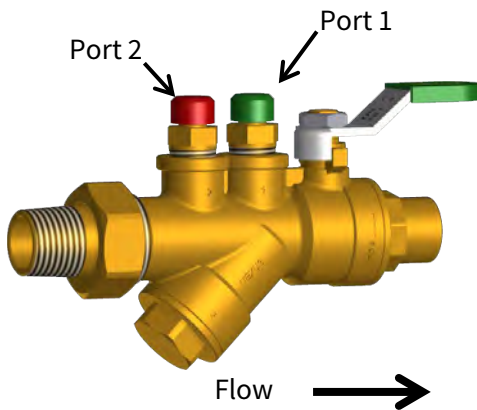

### Alternate Configuration

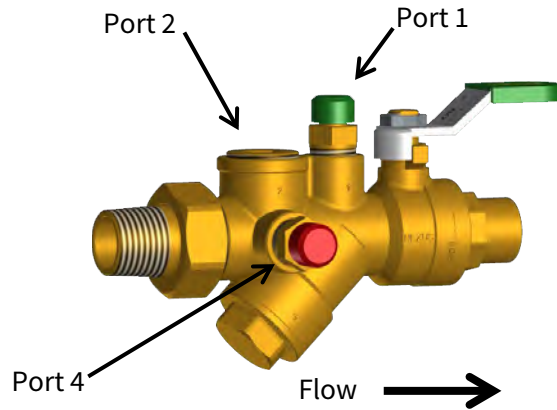

### UltraMatic™ Model UMS

The UltraMatic™ Model UMS is a simple SWT x SWT pressure independent automatic flow control valve (AFCV).



Refer to page 2 for installation procedure.  
 Refer to page 10 for valve identification.

### Straight Run Requirements

UltraMatic™ UMS does not typically require any straight pipe runs up or downstream. Changes in pipe diameter size at the valve inlet may cause turbulence impacting pressure drop readings.

### Accessory Port Locations

UltraMatic™ UMS does not have pressure and temperature test plugs. (See image below for reference).

#### Standard Configuration

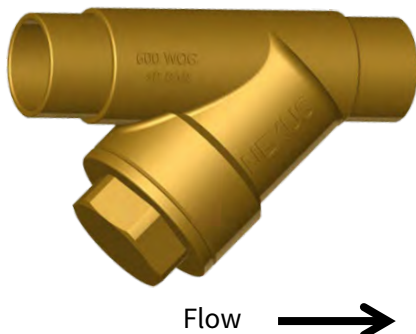

**Nexus Valve, Inc.**  
9982 E. 121<sup>st</sup> Street  
Fishers, IN 46037  
(888) 900-0947 (800) 900-8654 Fax  
info@nexusvalve.com www.nexusvalve.com

## ULTRAMATIC™

### UltraMatic™ Model UMF / UMNL

The UltraMatic™ Model UMF is a simple FNPT x FNPT pressure independent automatic flow control valve (AFCV).

**THIS VALVE DOES NOT MEET LEAD FREE / LOW LEAD REQUIREMENTS.**

The UltraMatic™ Model UMNL is a simple FNPT x FNPT pressure independent automatic flow control valve (AFCV) designed for use in domestic water systems and **does** meet lead free / low lead requirements.



Refer to page 2 for installation procedure.  
Refer to page 10 for valve identification.



**DO NOT OVERTIGHTEN THE THREADED CONNECTIONS! EXCESSIVE TIGHTENING WILL RESULT IN CRACKED VALVES RESULTING IN LEAKS AND CATESTOPHIC FAILURE.**

### Straight Run Requirements

UltraMatic™ UMF / UMNL does not typically require any straight pipe runs up or downstream. Changes in pipe diameter size at the valve inlet may cause turbulence impacting pressure drop readings.

### Accessory Port Locations

UltraMatic™ UMF / UMNL has two (2) pressure and temperature test plugs. (See image below on for reference).

#### Standard Configuration

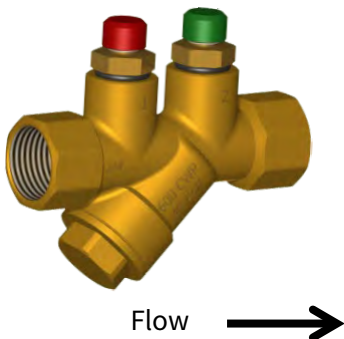

**Nexus Valve, Inc.**  
 9982 E. 121<sup>st</sup> Street  
 Fishers, IN 46037  
 (888) 900-0947 (800) 900-8654 Fax  
 info@nexusvalve.com www.nexusvalve.com

**Effective Date:** August 20, 2021

## ULTRAMATIC™

### UltraMatic™ Wafer Type

#### Models



UMW  
(2½"- 48")



UMT  
(2" & 2½")



UMG  
(2½"- 12")



UMWB  
(2½"- 6")



UMTB  
(2" & 2½")



UMGB  
(2½"- 6")

#### Installation

UltraMatic™ wafer type valves can be installed in horizontal and vertical planes. All hardware is provided through 12".

#### Straight Run Requirements

Nexus Valve recommends following ASHRAE plumbing standards for control valves (ASHRAE Handbook– HVAC Systems and Equipment—Hydronic Heating and Cooling Systems Design—Balance Fittings).

Avoid placing UMW type valves at pump discharge, immediately after 90's or directly coupled to eccentric reducers. Follow ASHRAE recommendations for straight run requirements.

#### Accessory Port Locations

The UltraMatic™ has a 1/4" NPT port (marked HI) designated for high-pressure, and a 1/4" NPT port (marked LO) designated for low-pressure, a 1/4" NPT port (#1) for instrument (accessory), and a 3/4" NPT port (#2) for thermometer well. On the opposite side a 3/4" NPT port (#3) is designated for a drain valve.



**Nexus Valve, Inc.**  
 9982 E. 121<sup>st</sup> Street  
 Fishers, IN 46037  
 (888) 900-0947 (800) 900-8654 Fax  
 info@nexusvalve.com www.nexusvalve.com

**Effective Date:** August 20, 2021

## ULTRAMATIC™



Refer to page 2 for installation procedure.  
 Refer to page 10 for valve identification.

### Accuracy

The UltraMatic™ has an accuracy of  $\pm 5\%$  and is ordered for a specific flow rate. The flow limiting cartridge has an operating range 2-45 PSID for example. The first number, 2, of this operating range is the minimum DP required to maintain constant flow and the second number, 45, is the maximum DP of the range for the specified GPM.

### Flow Verification

Since the GPM cannot be adjusted in the field, the pressure/temperature ports are supplied for flow verification purposes only. A meter kit, such as Nexus Valve's # MKA, may be used to assure that the valve is operating in its specified spring range. If the pressure drop across the valve falls within the operating range 2-45 PSID or 5-50 PSID, then the GPM will be in the specified flow range. Dirt or debris may cause a false reading. See typical control chart for Nexus UltraMatic™ on following page.

**Sample Performance of Nexus UltraMatic**

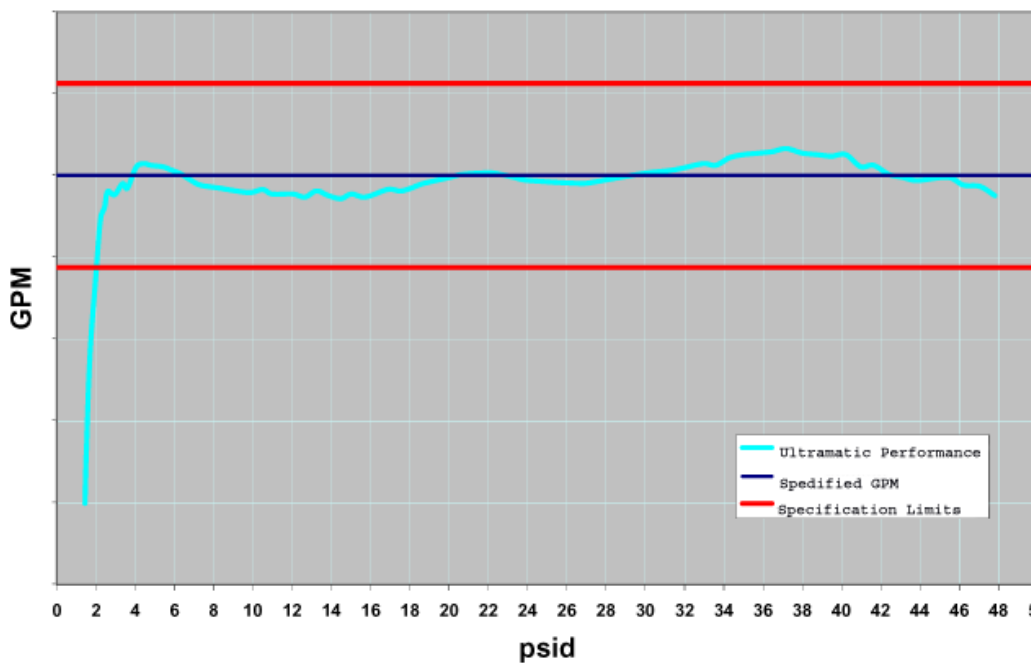

Refer to page 68 for meter kit operating instructions.

**Nexus Valve, Inc.**  
 9982 E. 121<sup>st</sup> Street  
 Fishers, IN 46037  
 (888) 900-0947 (800) 900-8654 Fax  
 info@nexusvalve.com www.nexusvalve.com

**Effective Date:** August 20, 2021

## ULTRAMATIC™

### Maintenance

- UltraMatic™ UM does not require any maintenance under normal operating conditions.
- It is recommended to visually inspect products on regular intervals.

### Cartridge Replacement

- For UM valves (1/2"-2-1/2") shut inlet and outlet isolation valves. Drain coil. Remove chamber cap on the bottom of the UltraMatic™.
- The cartridge may be removed without disrupting the piping. Remove cartridge by hand, no tools are necessary.
- Check for debris and remove it, if necessary.
- Replace EPDM gasket. Replace cartridge. Replace FKM o-ring on chamber cap.
- Screw chamber cap into valve body using the following hex sockets or wrenches:
- For Y1 & Y2 use hex socket #13/16"
  - For Y3 use hex socket #1 1/16"
  - For Y4 use wrench #32 mm
- Slowly open isolation valve. Purge air and check for leaks.

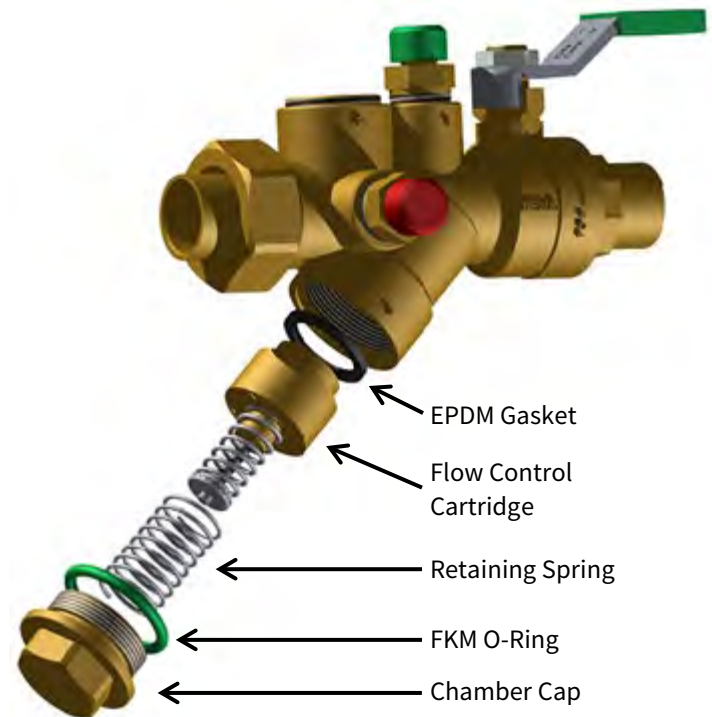

Some valves may come with a cartridge adapter.

**Nexus Valve, Inc.**9982 E. 121<sup>st</sup> Street

Fishers, IN 46037

(888) 900-0947 (800) 900-8654 Fax

info@nexusvalve.com www.nexusvalve.com

**Effective Date:** August 20, 2021

## ULTRAMATIC™

- Nexus Valve Tool Kit Part # TK is required for replacing the cartridges.
- Isolate the flow to the UltraMatic™, remove the studs or bolts, and remove the UltraMatic™ body from the line.
- Remove the retaining ring using the removal/installation pliers from Nexus Valve Tool Kit, and remove the cartridges by hand.
- Replace EPDM cartridge gaskets.
- Reinstall the replacement cartridge and fasten using the retaining ring with the removal/installation pliers from Nexus Valve Tool Kit.

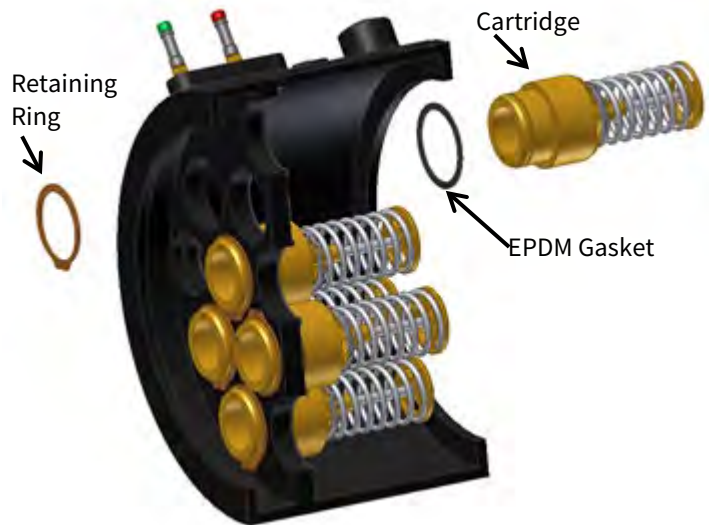

**Nexus Valve, Inc.**  
9982 E. 121<sup>st</sup> Street  
Fishers, IN 46037  
(888) 900-0947 (800) 900-8654 Fax  
info@nexusvalve.com www.nexusvalve.com

**Effective Date:** August 20, 2021

## DYNAMIC™

### Dynamic™

The Nexus Dynamic™ is a pressure independent control valve (PICV) which maintains constant flow independent of changes in pressure of the heating or cooling system.

Installed with an actuator, the Dynamic™ combines an automatic flow limiter with a two way control valve; having full control authority the valve reacts and adjusts the flow according to the building management system or room thermostat signal.

Without an actuator, the Dynamic™ works as an automatic flow limiter.

### General information

- Dynamic™ can be installed in horizontal and vertical planes.
- When installing Dynamic™, space around the valve must be provided for port access and cartridge removal.
- Each Dynamic™ has an internal cartridge that can be set to a specific flow rate (GPM).
- It is imperative that the valve be installed with correct direction of flow. There is an arrow on the side of the device indicating proper installation.
- Installation of a y-strainer is recommended upstream for any control valve or balancing device.
- A flushing / pre-setting cap is provided for system flushing. Maximum pressure during flushing is 230 PSI, maximum water temperature for flushing is 77°F when using the flushing cap. A BK Series bypass and flushing kit is recommended.
- The flow cartridge can be removed and installed using a 37 mm wrench. **DO NOT USE ANY TOOL ON THE SMALL NUT ON THE TOP OF THE CARTRIDGE.**
- For precise flow measuring, the Dynamic™ includes a built in venturi.
- Maximum differential pressure should not exceed 58 PSI. Note, this is across the valve, not just the venturi metering section.



To achieve maximum performance, the elimination of air in the fluid is required.



Do not back flush with the cartridge in the body. Nexus Valve recommends using an UltraBK™ Series bypass and flushing kit for flushing the hydronic system prior to start up and after periodic maintenance.



Refer to page 2 for installation procedure.  
Refer to page 10 for valve identification

### Straight Run Requirements

Dynamic™ does not typically require any straight pipe runs up or downstream. Changes in pipe diameter size at the valve inlet may cause turbulence impacting pressure drop readings.

**Nexus Valve, Inc.**  
9982 E. 121<sup>st</sup> Street  
Fishers, IN 46037  
(888) 900-0947 (800) 900-8654 Fax  
info@nexusvalve.com www.nexusvalve.com

**Effective Date:** August 20, 2021

## DYNAMIC™

### Setting the Flow

Before setting the design flow on the Dynamic™, the pump must be set at maximum capacity and all service valves in the system must be in the fully open position. The differential pressure across the Dynamic™ must at all times not exceed 58 PSI.

The design flow is easily adjusted with the included pre-setting tool. After connecting a differential pressure gauge to the Dynamic™, the flow reading is provided for precise flow tuning.

The pre-setting tool is mounted on top of the valve covering the valve stem. The scale on the pre-setting tool is read against the marking on the brass housing of the valve.

The flow is set by turning the pre-setting tool from 0-90°. Each marking on the scale indicates a step of 10%. When the required flow is set and the starting differential pressure is provided, the flow is kept constant.

Dynamic™ with pre-setting tool mounted.

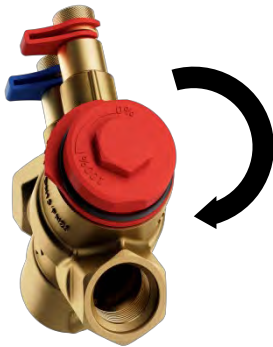

Dynamic™ with 100% Pre-set flow



Dynamic™ with 50% Pre-set flow



**Nexus Valve, Inc.**  
9982 E. 121<sup>st</sup> Street  
Fishers, IN 46037  
(888) 900-0947 (800) 900-8654 Fax  
info@nexusvalve.com www.nexusvalve.com

**Effective Date:** August 20, 2021

## DYNAMIC™

### Accessory Port Locations

Dynamic™ comes equipped with two (2) PT test plugs. Standard configuration will have the port # 1 designated for high-pressure and port # 2 for low-pressure.

#### Standard Configuration

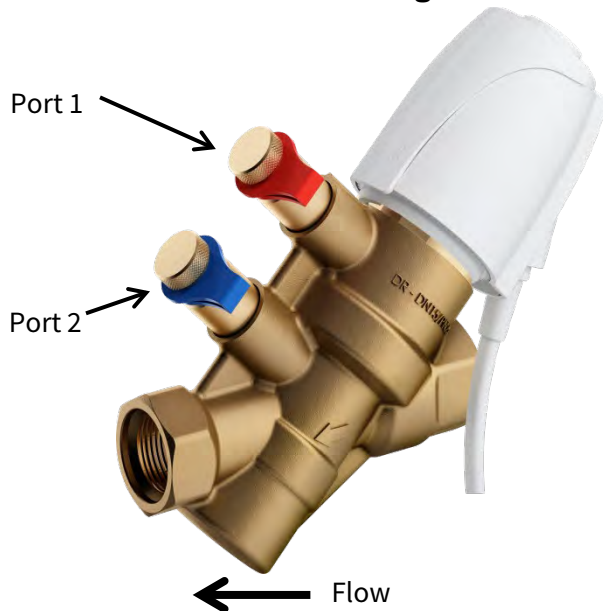

### Cartridge Installation / Removal



**Nexus Valve, Inc.**  
 9982 E. 121<sup>st</sup> Street  
 Fishers, IN 46037  
 (888) 900-0947 (800) 900-8654 Fax  
 info@nexusvalve.com www.nexusvalve.com

**Effective Date:** August 20, 2021

**DYNAMIC™**

## Dynamic™ Flow Chart

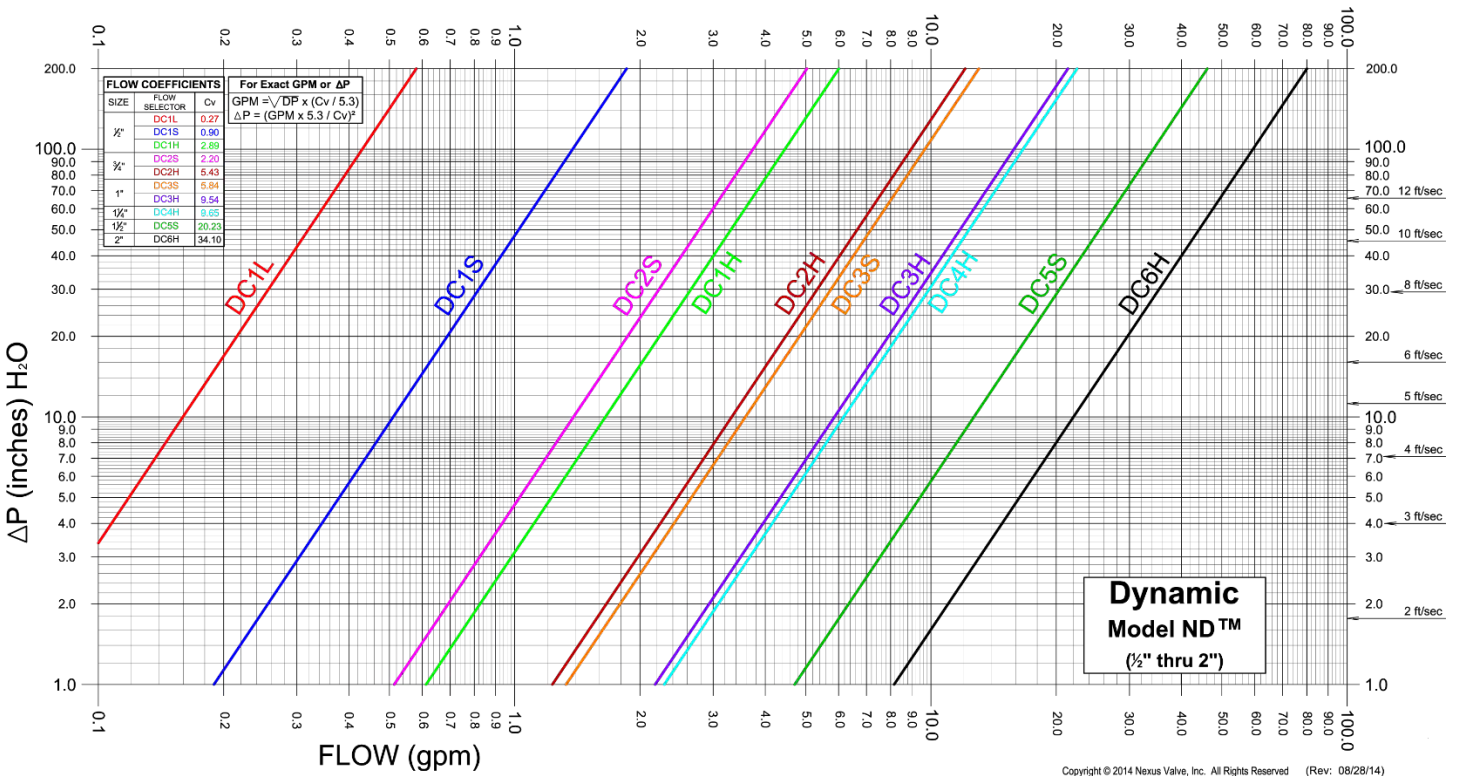



# Installation - Operation - Maintenance

**Nexus Valve, Inc.**  
 9982 E. 121<sup>st</sup> Street  
 Fishers, IN 46037  
 (888) 900-0947 (800) 900-8654 Fax  
 info@nexusvalve.com www.nexusvalve.com

**Effective Date:** August 20, 2021

**DYNAMIC™**

## Pre-setting Data

		GPM									
		DC050L	DC050S	DC050H	DC075S	DC075H	DC100S	DC100H	DC125H	DC150S	DC200H
<b>Pre-Set Knob Setting</b>	100%	0.52	1.98	-	3.88	9.78	10.30	14.66	0.00	33.68	-
	95%	0.52	1.97	-	3.81	9.64	10.14	14.46	9.51	33.41	-
	90%	0.51	1.95	-	3.74	9.51	9.99	14.27	19.02	33.13	-
	85%	0.50	1.93	-	3.61	9.19	9.59	13.87	18.70	32.73	51.52
	80%	0.49	1.92	6.18	3.49	8.88	9.19	13.47	18.39	32.34	51.52
	75%	0.48	1.90	5.98	3.31	8.56	8.76	13.08	18.07	32.12	49.34
	70%	0.48	1.89	5.79	3.14	8.24	8.32	12.68	17.75	31.90	47.16
	65%	0.47	1.85	5.55	3.01	7.89	8.04	12.34	17.34	30.45	45.37
	60%	0.46	1.82	5.31	2.88	7.53	7.77	12.01	16.93	29.01	43.59
	55%	0.44	1.79	5.07	2.74	7.17	7.45	11.69	16.39	27.98	41.71
	50%	0.43	1.76	4.83	2.60	6.82	7.13	11.38	15.85	26.95	39.83
	45%	0.40	1.71	4.58	2.44	6.53	6.84	11.00	15.22	26.15	38.20
	40%	0.37	1.66	4.32	2.28	6.25	6.54	10.62	14.58	25.36	36.58
	35%	0.34	1.59	4.04	2.16	5.96	6.22	10.18	13.79	24.47	33.35
	30%	0.30	1.51	3.76	2.03	5.67	5.90	9.75	13.00	23.58	30.12
	25%	0.26	1.39	3.47	1.92	5.37	5.61	9.39	12.21	22.59	28.73
	20%	0.21	1.27	3.17	1.81	5.07	5.31	9.03	11.41	21.60	27.34
	15%	0.21	1.07	2.71	1.71	4.76	4.95	8.72	10.66	20.51	26.15
10%	-	0.87	2.26	1.62	4.44	4.60	8.40	9.91	19.42	24.97	
5%	-	0.56	1.82	1.52	3.96	4.32	8.00	9.19	18.23	24.17	



**Nexus Valve, Inc.**  
 9982 E. 121<sup>st</sup> Street  
 Fishers, IN 46037  
 (888) 900-0947 (800) 900-8654 Fax  
 info@nexusvalve.com www.nexusvalve.com

**Effective Date:** August 20, 2021

## ULTRAXB™ ORTURI

### UltraXB™ Orturi

The UltraXB™ Orturi is a manually adjustable modified venturi circuit balancing valve.

#### General Information

- UltraXB™ may be installed in horizontal or vertical planes.
- When installing UltraXB™, space around the valve must be provided for port access and rotation of the handle.
- Installation of a y-strainer is recommended upstream of any control valve or balancing device.
- To achieve maximum performance the elimination of air in the fluid is required.
- Straight run requirements for the UltraXB™ are generally not necessary. Some unique applications may require straight pipe for accurate pressure drop readings.



If reductions of more than one pipe size is made, 5 pipe diameters upstream and 2 pipe diameters downstream may be required to ensure a stable pressure drop reading when the pipe size leading to the UltraXB™ is smaller than the pipe size of the UltraXB™ due to placement of a TCV, elbow or other obstruction. See image below.

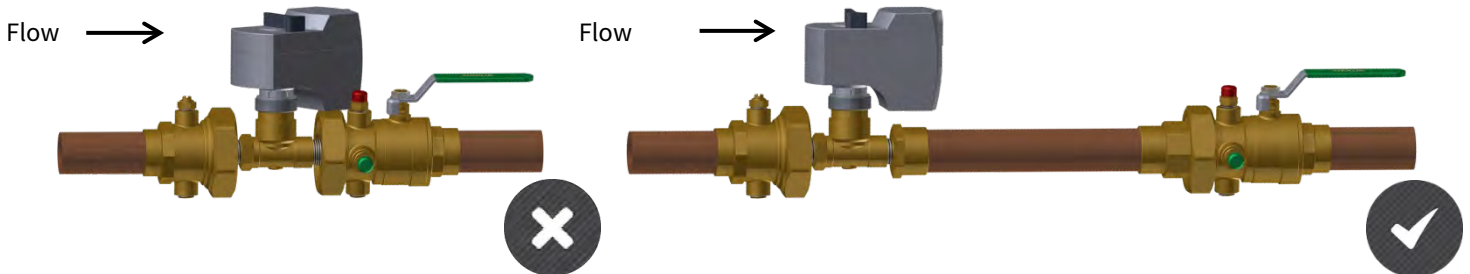

#### Accessory Locations

UltraXB™ will have the port #1 or port #3 designated for high pressure and port #2 for low-pressure. Optional accessories will determine the high pressure port configuration. (See image page 24)



Refer to page 2 for installation procedure.  
 Refer to page 10 for valve identification.

**Nexus Valve, Inc.**  
 9982 E. 121<sup>st</sup> Street  
 Fishers, IN 46037  
 (888) 900-0947 (800) 900-8654 Fax  
 info@nexusvalve.com www.nexusvalve.com

**Effective Date:** August 20, 2021

## ULTRAXB™ ORTURI

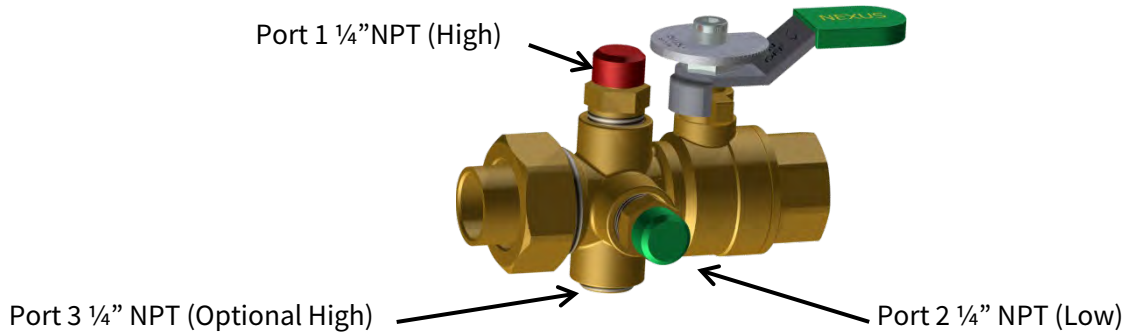

### Adjusting & Balancing

- The UltraXB™ should be set in the field by a qualified balancing contractor. The desired flow rate, is set by slowly adjusting the supplied ball valve until the differential pressure reading across the selected modified venturi reaches the desired pressure drop.
- Once the desired flow rate is achieved (refer to graph on page 25 or available for download at the Nexus Valve website: [www.nexusvalve.com](http://www.nexusvalve.com)), rotate the memory stop, which is located on the top of the ball valve handle, until it hits the valve stop. Then lock it with an allen wrench . A 4 mm wrench is required for 1/2" - 1 1/4" and 5 mm for 1 1/2" - 2 1/2" respectively.



### Meter Kits

A differential pressure meter kit, such as Nexus #MKM models, must be used to measure the differential pressure in inches of water column across the modified venturi. If using a Nexus Valve meter kit, connect the red hose to the upstream, high-pressure port (usually in port #1). The green hose should be connected to the low pressure port (always in port #2).



Refer to page 69 for meter kit operating instructions.

**Nexus Valve, Inc.**  
 9982 E. 121<sup>st</sup> Street  
 Fishers, IN 46037  
 (888) 900-0947 (800) 900-8654 Fax  
 info@nexusvalve.com www.nexusvalve.com

**Effective Date:** August 20, 2021

## ULTRAXB™ ORTURI

### Accuracy

UltraXB™ accuracy is +/- 3%.

### Maintenance

- UltraXB™ does not require any maintenance under normal operating conditions.
- It is recommended to visually inspect products on regular intervals.

### Flow Charts



Full scale flow charts can be obtained in the Nexus Valve Products Catalog as well as on-line at [www.nexusvalve.com](http://www.nexusvalve.com).

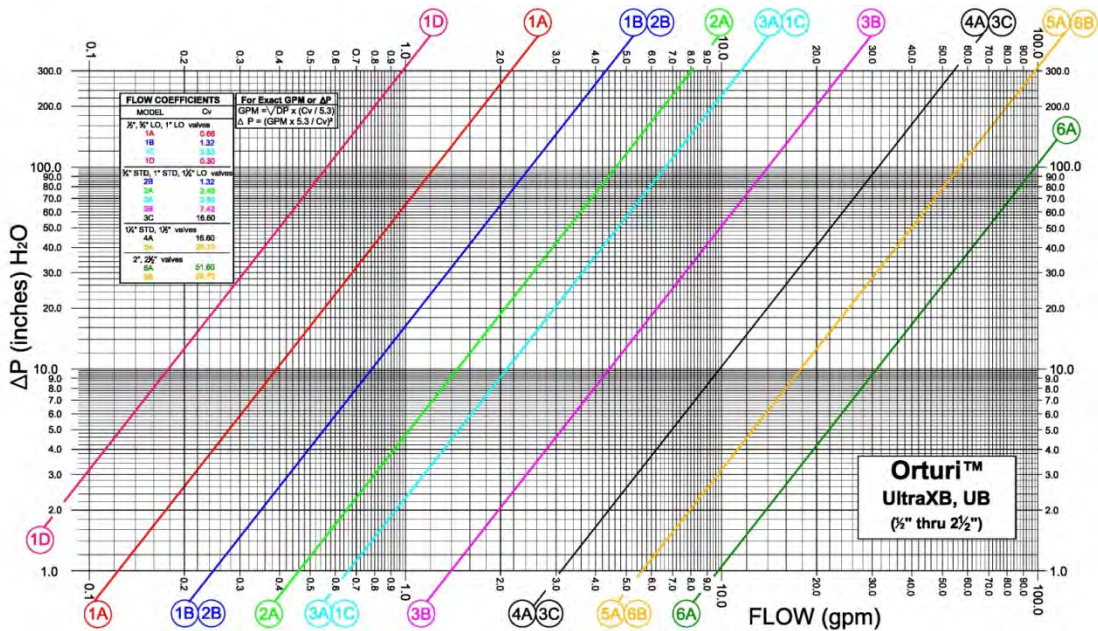

**Nexus Valve, Inc.**  
9982 E. 121<sup>st</sup> Street  
Fishers, IN 46037  
(888) 900-0947 (800) 900-8654 Fax  
info@nexusvalve.com www.nexusvalve.com

**Effective Date:** August 20, 2021

## ULTRAMB™

### UltraMB™

#### General Information

The UltraMB™ is a multi-turn manually adjustable balancing valve with an integrated isolation valve and union end.

- UltraMB™ may be installed in horizontal or vertical planes.
- When installing UltraMB™, space around the valve must be provided for port access and rotation of the handle.
- Installation of a y-strainer is recommended upstream of any control valve or balancing device.
- To achieve maximum performance, the elimination of air in the fluid is required.
- Straight run requirements for the UltraMB™ are generally not necessary. Some unique applications may require straight pipe for accurate pressure drop readings.



If reductions of more than one pipe size is made, 5 pipe diameters upstream and 2 pipe diameters downstream may be required to ensure a stable pressure drop reading when the pipe size leading to the UltraMB™ is smaller than the pipe size of the UltraMB™ due to placement of a TCv, elbow or other obstruction. See image below.

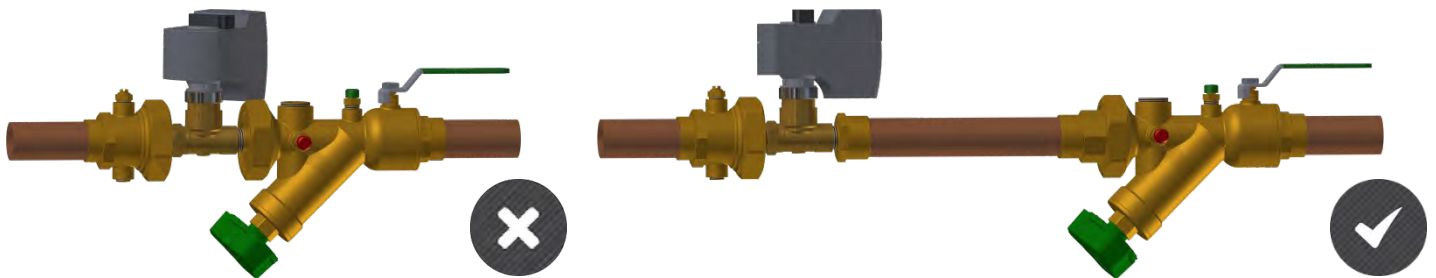

Refer to page 2 for installation procedure.  
Refer to page 10 for valve identification.

**Nexus Valve, Inc.**  
 9982 E. 121<sup>st</sup> Street  
 Fishers, IN 46037  
 (888) 900-0947 (800) 900-8654 Fax  
 info@nexusvalve.com www.nexusvalve.com

**Effective Date:** August 20, 2021

## ULTRAMB™

### Accessory Locations

#### Standard Configuration

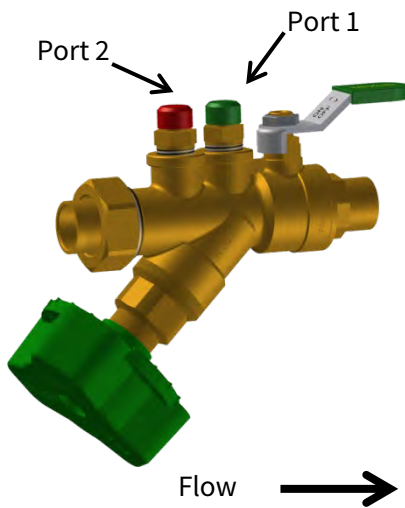

#### Alternate Configuration

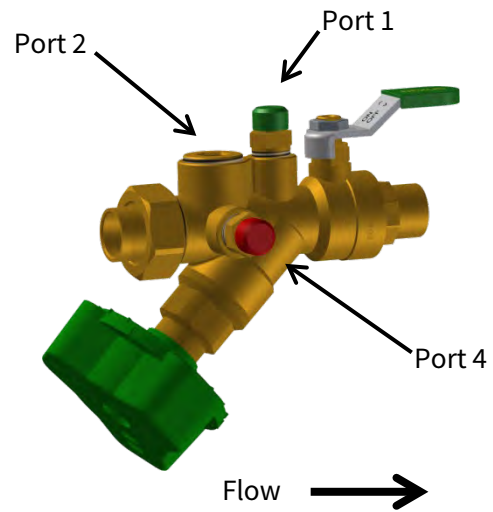

### UltraMB™ Model MBNL

The UltraMB™ Model MBNL is a FNPT x FNPT Lead Free globe style balancing valve.



Refer to page 2 for installation procedure.  
 Refer to page 10 for valve identification.



**DO NOT OVERTIGHTEN THE THREADED CONNECTIONS! EXCESSIVE TIGHTENING WILL RESULT IN CRACKED VALVES RESULTING IN LEAKS AND CATESTOPHIC FAILURE.**

### Straight Run Requirements

When installing the UltraMB™ Model MBNL, Five (5) pipe diameters upstream and two (2) pipe diameters downstream may be required to ensure a stable pressure drop readings.

**Nexus Valve, Inc.**  
 9982 E. 121<sup>st</sup> Street  
 Fishers, IN 46037  
 (888) 900-0947 (800) 900-8654 Fax  
 info@nexusvalve.com www.nexusvalve.com

**Effective Date:** August 20, 2021

## ULTRAMB™

### Accessory Port Locations

UltraMB™ MBNL has two (2) pressure and temperature test plugs. (See image below on for reference).

#### Standard Configuration

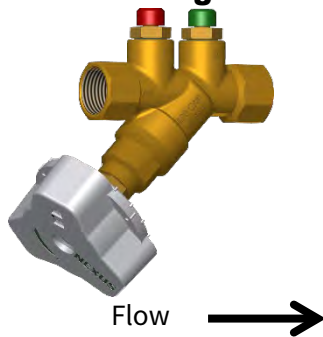

### Adjusting & Balancing

- The UltraMB™ should be set in the field by a qualified balancing contractor. The desired flow rate and pressure drop is set by slowly adjusting the green handle until the prescribed flow rate is achieved at a specified pressure drop.
- The specified flow rate is determined by noting the two digit number on the adjusting handle (note this number changes from 0.0 to 9.9 as the handle is rotated counterclockwise) and the recorded pressure drop across the red and green test ports on the valve.
- Once the desired flow rate is obtained the UltraMB™ may be locked in position with the supplied tie wrap by sliding it through the handle holes and tightening the tie wrap against the handle.
- For reference the tie wrap may be marked with the handle number with a pen or pencil.
- See handle & tie image on page 28.

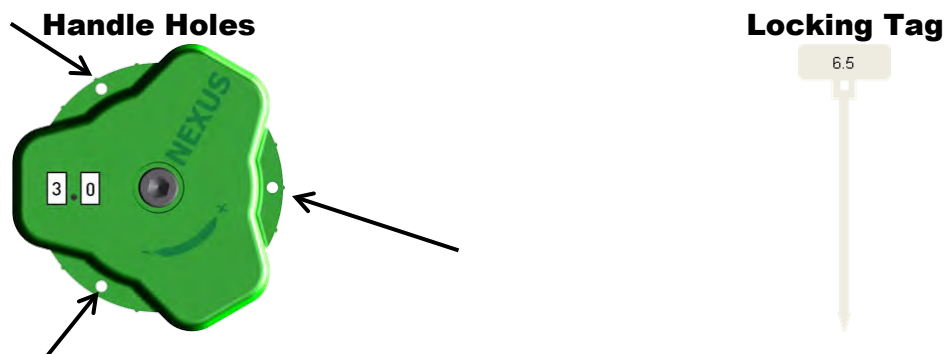

### Meter Kits

A differential pressure meter kit, such as Nexus #MKM models, must be used to measure the differential pressure in inches of water column across the modified venturi. If using a Nexus Valve meter kit, connect the red hose to the upstream, high-pressure port (usually in port #2 or 4). The green hose should be connected to the low pressure port (always in port #1).

**Nexus Valve, Inc.**  
 9982 E. 121<sup>st</sup> Street  
 Fishers, IN 46037  
 (888) 900-0947 (800) 900-8654 Fax  
 info@nexusvalve.com www.nexusvalve.com

**Effective Date:** August 20, 2021

## ULTRAMB™



Refer to page 69 for meter kit operating instructions.

### Accuracy

UltraMB™ accuracy is +/- 5%.

### Maintenance

- UltraMB™ does not require any maintenance under normal operating conditions.
- It is recommended to visually inspect products on regular intervals.

### Flow Charts & Flow Calculators

When balancing, refer to the following flow charts or use the hand calculators



Full scale flow charts can be obtained in the Nexus Valve Products Catalog as well as on-line at [www.nexusvalve.com](http://www.nexusvalve.com).

### Basic Calculator

**Cv Values for UltraMB Handle Turns**

Turns	MB1	MB2	MB3	MB4
	Valve Sizes:			
	1/2", 3/4"LO, 1"LO	3/4"STD, 1"STD, 1-1/4"LO	1-1/4"STD, 1-1/2"	2", 2-1/2"
0.2	0.2	0.4	0.9	N/A
0.3	0.3	0.7	1.0	N/A
0.4	0.3	0.6	1.3	N/A
0.5	0.4	0.8	1.4	2.3
0.6	0.5	0.8	1.5	2.4
0.7	0.5	0.9	1.6	2.6
0.8	0.6	0.9	1.7	2.6
0.9	0.7	0.9	2.0	2.8
1.0	0.7	1.0	2.0	2.8
1.5	1.1	1.3	2.8	3.5
2.0	1.3	1.5	3.4	4.5
2.5	1.6	1.9	4.6	5.9
3.0	2.0	2.3	5.5	6.4
3.5	2.4	2.7	6.6	9.9
4.0	2.8	3.2	7.8	12.0
4.5	3.5	3.6	9.1	15.2
5.0	3.7	4.2	10.7	18.1
5.5	4.1	4.7	11.9	21.7
6.0	4.6	5.5	12.9	25.3
6.5	5.3	6.0	14.0	29.0
7.0	5.8	6.8	15.2	32.9
7.5	6.5	7.6	16.3	36.5
8.0	7.2	8.3	17.4	39.4
8.5	7.8	9.0	18.5	42.1
9.0	8.6	9.7	19.7	45.0
9.5	8.8	10.7	20.6	48.4
10.0	9.4	11.6	21.6	50.8

#### How to calculate the Flow through UltraMB using: Cv values

1. Select column MB1, MB2, MB3, MB4 for the valve being used
2. Read the Handle Turns counter on the valve
3. Scan the MB column for your valve and regard the Cv value for your turns
4. Use the following equations to calculate flow

If PSID is in pounds/square inch

$$GPM = Cv \cdot \sqrt{\Delta P_{PSI}}$$

If PSID is in Inches of Water

$$GPM = \sqrt{\Delta P_{inH_2O}} \cdot Cv / 5.3$$

#### How to determine UltraMB Handle Turns using: GPM and Pressure Differential (ΔP)

1. If GPM and required pressure drop is known, calculate the required Cv using the following equations:

If PSID is in pounds/square inch

$$Cv = GPM / \sqrt{\Delta P_{PSI}}$$

If PSID is in Inches of Water

$$Cv = GPM \cdot 5.3 / \sqrt{\Delta P_{inH_2O}}$$

2. Locate Column for Valve being used
3. Scan down column until closest Cv to required is located
4. Read Turn number in first column

**Nexus Valve, Inc.**

9982 E. 121<sup>st</sup> Street

Fishers, IN 46037

(888) 900-0947 (800) 900-8654 Fax

info@nexusvalve.com www.nexusvalve.com

**Effective Date:** August 20, 2021

## ULTRAMB™

### Nomograph Calculator

How to use the Nomograph to find the correct handle setting for your application:

1. Find the required GPM on the GPM Scale (example: 20 GPM - Point A on Nomograph)
2. Draw a line from the GPM value to the required differential pressure on the PSID scale (example: 20 In H<sub>2</sub>O - Point B on Nomograph)
3. Note where the straight line crosses the Cv scale (example: Point C or approximately 22)
4. From the intersected point on the Cv scale draw a horizontal line through the MB valve scale (example: Point D on MB4 or slightly less than 6 turns)

How to use the Nomograph to find GPM:

1. Find your MB scale on the Nomograph (example: MB1)
2. Locate the turn setting for the valve (example: handle set at 3 turns - Point E on the Nomograph)
3. Draw a horizontal line from the turns setting to the Cv scale (example: line E-F, read Cv of 2.0)
4. Draw a line from the PSID value on the PSID scale through the located Cv value (example: line G-F for a PSID of 2.0)
5. Continue the straight line (shown in red) until it intersects with the GPM scale (example: line F-H)
6. Read the GPM value on the GPM Scale (example: GPM equal approximately 3 GPM - Point H)

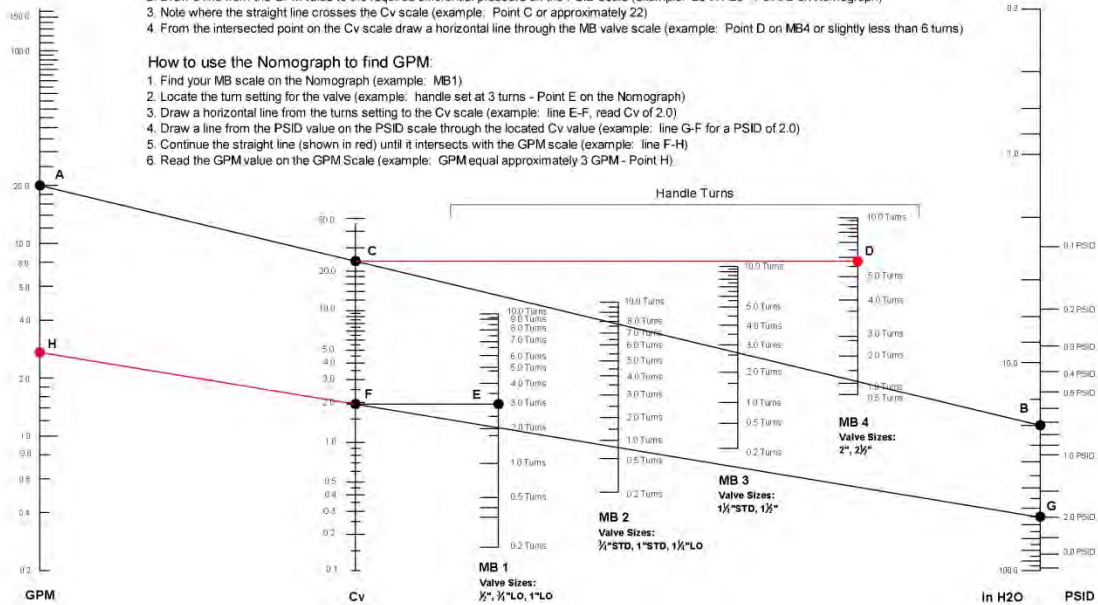

### Flow Chart (1/2", 3/4", 1"L)

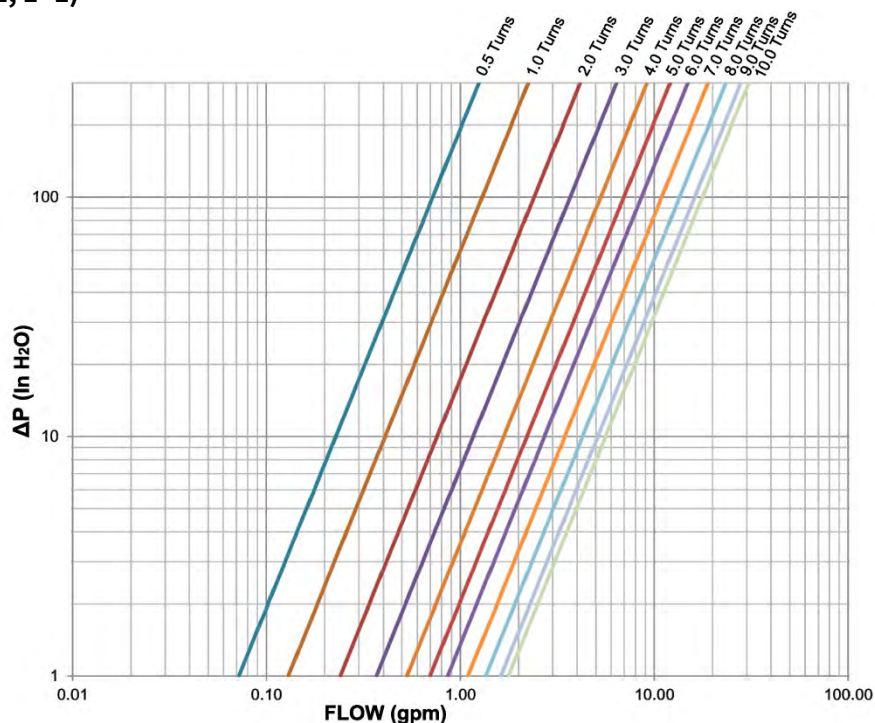



**Nexus Valve, Inc.**  
 9982 E. 121<sup>st</sup> Street  
 Fishers, IN 46037  
 (888) 900-0947 (800) 900-8654 Fax  
 info@nexusvalve.com www.nexusvalve.com

**Effective Date:** August 20, 2021

## ULTRAMB™

**Flow Chart (3/4", 1", 1 1/4"L)**

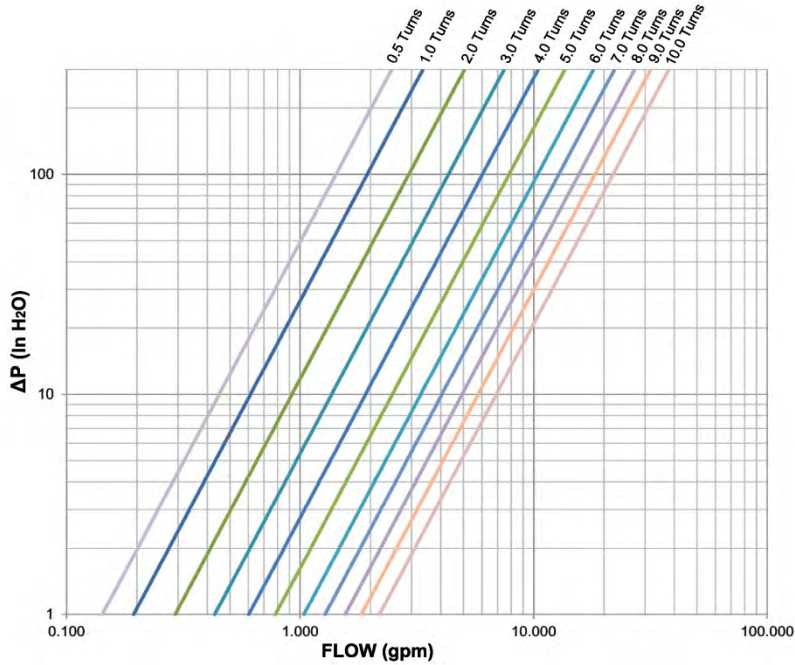

**Flow Chart (1 1/4", 1 1/2")**

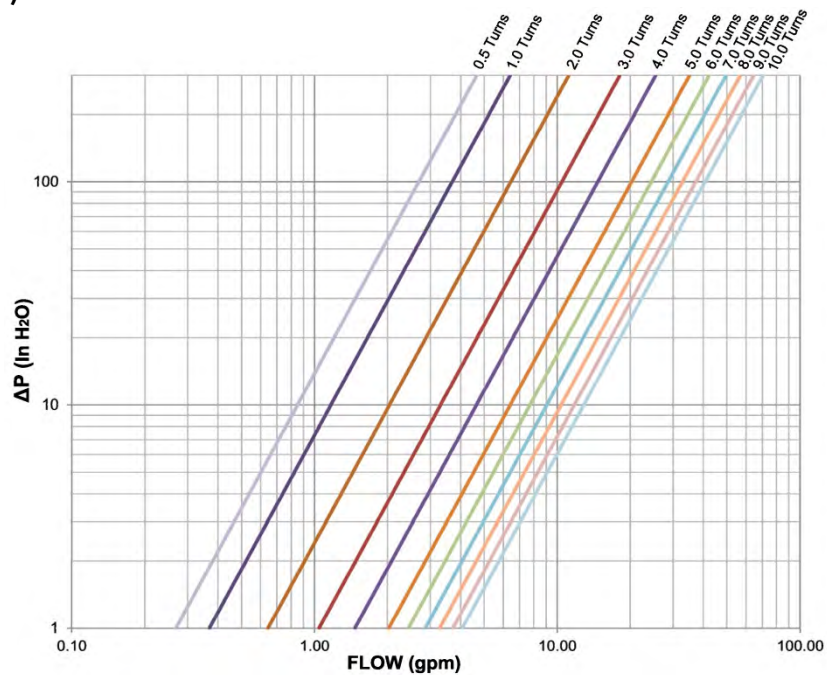



# Installation - Operation - Maintenance

**Nexus Valve, Inc.**  
9982 E. 121<sup>st</sup> Street  
Fishers, IN 46037  
(888) 900-0947 (800) 900-8654 Fax  
info@nexusvalve.com www.nexusvalve.com

**Effective Date:** August 20, 2021

**ULTRAMB™**

## Flow Chart (2", 2½")

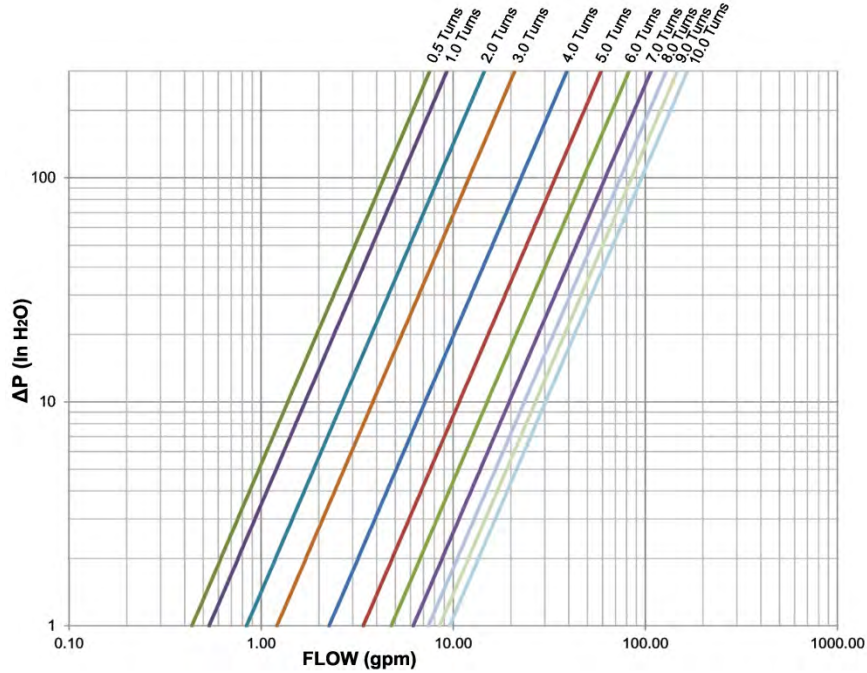

**Nexus Valve, Inc.**  
 9982 E. 121<sup>st</sup> Street  
 Fishers, IN 46037  
 (888) 900-0947 (800) 900-8654 Fax  
 info@nexusvalve.com www.nexusvalve.com

**Effective Date:** August 20, 2021

## NEXTROL™

### Nextrol™

Nextrol™ is a manually adjustable balancing valve and metering station which uses the TwinTube™ pitot tube for accurately measuring differential pressure.



Please note that the Nextrol™ accessories are packaged separately to avoid damage during shipping. Accessory packages include all plugs necessary to install in any unused ports as well as TwinTube™. Valve bodies are packaged separately and identified appropriately.

### Models

**NXFB**



**NXTB**



**NXGB**



### General Installation Notes

- Installation of a y-strainer is recommended upstream of any control valve or balancing device.
- To achieve maximum performance, the elimination of air in the fluid is required.
- Valves should be installed with the disc in the closed position to prevent possible damage to disc edge. Flanged models use standard ANSI 125# class flanges (also mates to 150# class flanges). Assembly may be accomplished with standard gaskets and hardware. Butterfly valves should be checked for free unobstructed disc movement.



**Nexus Valve, Inc.**  
9982 E. 121<sup>st</sup> Street  
Fishers, IN 46037  
(888) 900-0947 (800) 900-8654 Fax  
info@nexusvalve.com www.nexusvalve.com

**Effective Date:** August 20, 2021

---

## NEXTROL™

---

### Straight Run Requirements

The Nextrol™ requires a minimum of five (5) straight upstream pipe diameters and two (2) downstream. The Nextrol™ already has the required downstream pipe diameters built into the unit when TwinTube™ is installed in port #1.

### Adjusting & Balancing

- The Nextrol™ should be adjusted in the field by an experienced balance contractor.
- The desired flow rate is set by slowly adjusting the supplied butterfly valve until the differential pressure reading across the TwinTube™ reaches the desired pressure drop.
- Multiple passes are usually required to properly balance the system.
- Once this is achieved, lock the memory stop, which is located on the top works of the butterfly valve handle.



The readout instrument should be located below the TwinTube™. This prevents air entrapment in the instrument lines. Instrument lines should be properly sloped down ½” per foot with no high points that may cause air entrapment. If this is not possible, air vents must be placed at any high points in the piping. To ensure the quality of the reading, the best orientation of the TwinTube™ may be vertically down.

### Meter Kits

A DP meter kit, such as Nexus #MKM models, must be used to measure the differential pressure. If using a Nexus Valve meter kit, connect the red hose to the high-pressure port, typically indicated by the red cap, of the TwinTube™, and the green hose to the low-pressure port of the TwinTube™, typically indicated by a green cap.



Refer to page 69 for meter kit operating instructions.  
Refer to page 9 for bolting & tightening specifications.  
Refer to page 10 for valve identification.

### Maintenance

- The Nextrol™/TwinTube™ does not require maintenance under normal operating conditions.
- It is recommended to visually inspect products on regular intervals.

### TwinTube™ Function

The TwinTube™ pitot produces a differential pressure (DP) signal proportional to the square of the flow rate. The signal has two parts: the high pressure “P1” which is produced by the velocity of the liquid at the upstream tube and the low pressure “P2” which is static pressure downstream of the second tube. The differential reading taken at the TwinTube™ is:  $DP=P1-P2$

**Nexus Valve, Inc.**  
9982 E. 121<sup>st</sup> Street  
Fishers, IN 46037  
(888) 900-0947 (800) 900-8654 Fax  
info@nexusvalve.com www.nexusvalve.com

**Effective Date:** August 20, 2021

## NEXTROL™



Align tubes parallel to pipe.

“P1” is upstream - high pressure (velocity pressure)

“P2” is downstream - low pressure (static pressure).

The TwinTube™ is bi-directional when installed with proper straight pipe diameters.

Adjust 3/4” bushing as necessary to align TwinTube™ parallel to pipe. It is not necessary to anchor the TwinTube™ to the pipe, as it is blowout proof.

A minimum of five (5) straight pipe diameters is required upstream of the TwinTube™ to ensure accuracy.

A minimum of two (2) straight pipe diameters is required downstream.

A Nextrol™ flow or balancing station has the minimum two (2) straight pipe diameters built in.

**Nexus Valve, Inc.**  
 9982 E. 121<sup>st</sup> Street  
 Fishers, IN 46037  
 (888) 900-0947 (800) 900-8654 Fax  
 info@nexusvalve.com www.nexusvalve.com

**Effective Date:** August 20, 2021

## NEXTROL™

### Nextrol™ / TwinTube™ Flow Chart



Full scale flow charts can be obtained in the Nexus Valve Products Catalog as well as on-line at [www.nexusvalve.com](http://www.nexusvalve.com).

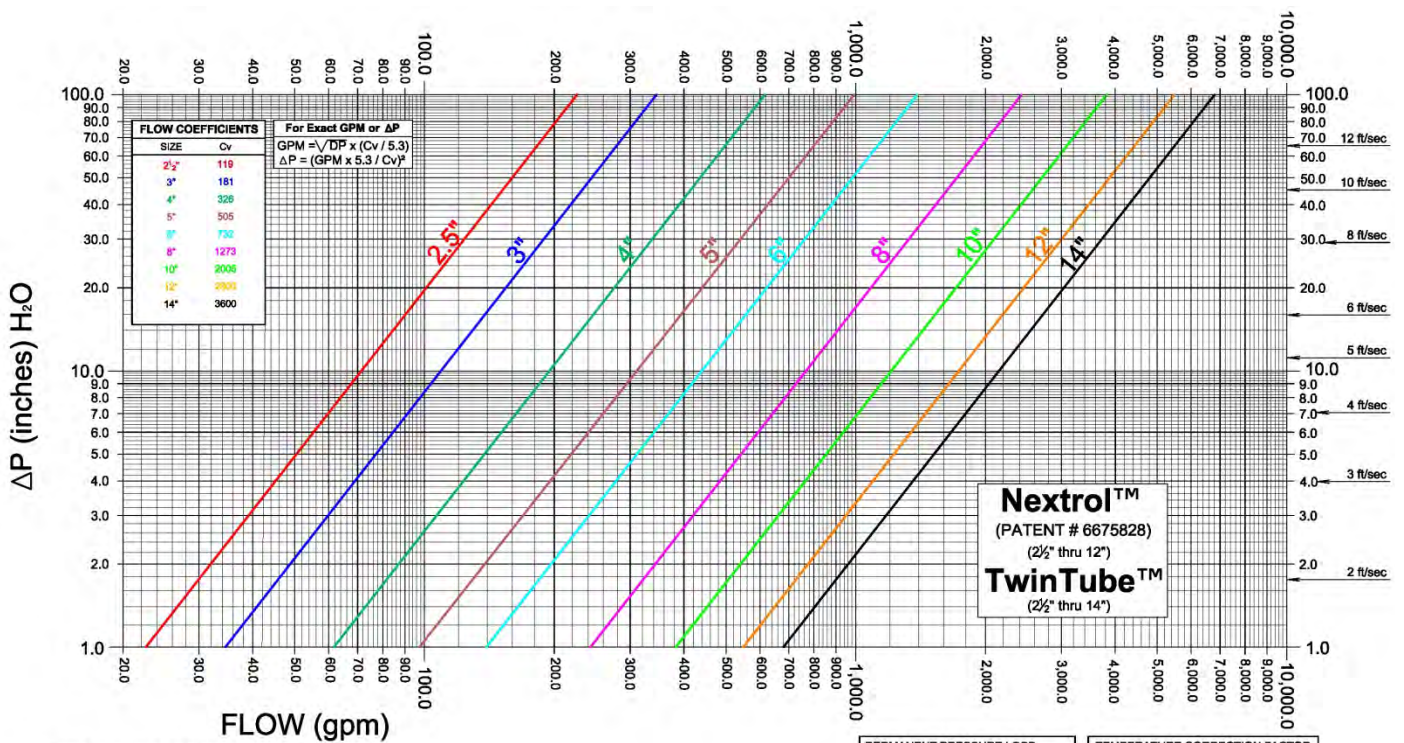

**HOW TO DETERMINE THE FLOW**

1. Enter the chart with the ΔP (differential pressure) reading.
2. Go horizontally across to the size of the Nextrol.
3. Go vertically up or down to read the GPM (flow).

**PERMANENT PRESSURE LOSS**

The approximate total pressure loss is equal to 10% of the differential pressure (ΔP) reading at the Twin Tube.

**TEMPERATURE CORRECTION FACTOR**

155°F = 1.01 X GPM  
 205°F = 1.02 X GPM  
 ACCURACY @ 5 ft/sec or less: ±1.00%  
 REPEATABILITY: ±0.02%

**Nexus Valve, Inc.**  
9982 E. 121<sup>st</sup> Street  
Fishers, IN 46037  
(888) 900-0947 (800) 900-8654 Fax  
info@nexusvalve.com www.nexusvalve.com

**Effective Date:** August 20, 2021

## ULTRAMBF™

### UltraMBF™

The UltraMBF™ is a manually adjustable balancing valve where adjustment is required at strategic points to improve the efficiency of the system.



Please note that the UltraMBF™ accessories are packaged separately to avoid damage during shipping. Accessory packages include all P/T test plugs and any other plugs necessary to install in any unused ports. Valve bodies are packaged separately and identified appropriately.

### Models:



### General Installation Notes

- Installation of a y-strainer is recommended upstream of any control valve or balancing device.
- To achieve maximum performance, the elimination of air in the fluid is required.
- Valves should be installed with the disc in the closed position to prevent possible damage to disc edge. Flanged models use standard ANSI 125# class flanges (also mates to 150# class flanges). Assembly may be accomplished with standard gaskets and hardware. Butterfly valves should be checked for free unobstructed disc movement.
- Do not lift the UltraMBF™ by the handle.
- The UltraMBF™ is unidirectional. Please observe the flow direction arrow on the valve body.
- Do not weld the flanges to the pipe or to flange adapters.



Refer to page 9 for Bolting & Tightening Specifications.  
Position indicator may be repositioned in 4 positions to allow ease in viewing. See instructions on page 38.

**Nexus Valve, Inc.**  
 9982 E. 121<sup>st</sup> Street  
 Fishers, IN 46037  
 (888) 900-0947 (800) 900-8654 Fax  
 info@nexusvalve.com www.nexusvalve.com

**Effective Date:** August 20, 2021

## ULTRAMBF™

### Straight Run Requirements

The UltraMBF™ requires a minimum of five (5) straight upstream pipe diameters and two (2) downstream.

### Setting the Hand Wheel

The hand wheel mounting (Fig. 1A) can be set for easier viewing by:

1. Remove the upper center screw in the handle (Fig. 1B)
2. Remove the indicator assembly by pulling the handle and the lower parts away from the valve. Ensure that the two pieces remain in constant contact – **DO NOT ALLOW THEM TO SEPARATE. FAILURE TO KEEP THE TWO PARTS TIGHTLY TOGETHER MAY NECESSITATE RECALIBRATION OF THE SETTING WHEELS.** (Fig. 1B)
3. Rotate the handle assembly by 90° - 180° - 270° (Fig. 1C)
4. Place the assembly back over the valve bonnet (Fig. 1D)
5. Replace the upper screw.

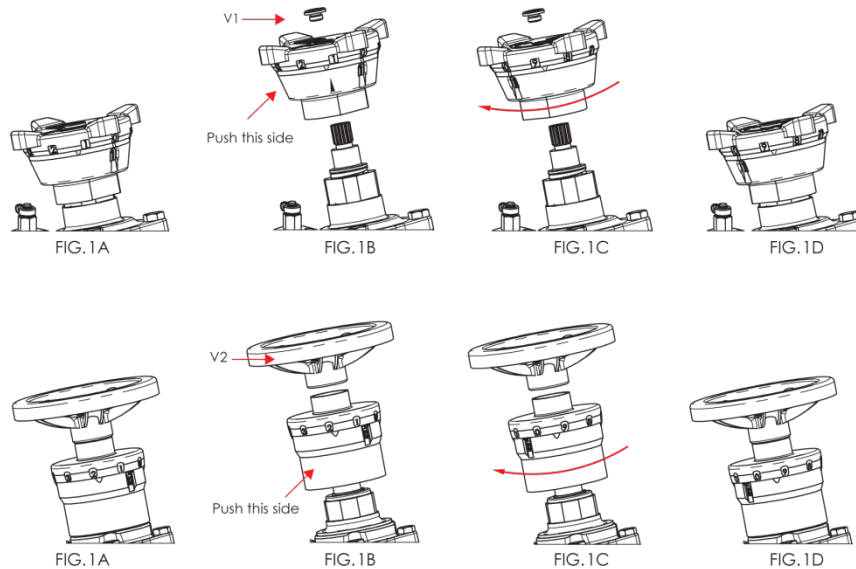

### Adjusting & Balancing

- Setting the handle – a fully closed valve will indicate a 0-0 reading with the basic 0 being on the lower scale and the fine setting being on the upper scale.



As the handle is rotated, the upper number will increase from 0 – 9 and then increment the basic lower setting number by 1. To read the valve setting, the basic number is the units number and the handle number is the digit number. (Basic).(Digit)

- Using the correct flow chart for the selected valve, close the valve ensuring the setting reads approximately 0.0.
- From the flow chart, check the selected pressure and GPM required and note the closest handle setting.



**Nexus Valve, Inc.**  
 9982 E. 121<sup>st</sup> Street  
 Fishers, IN 46037  
 (888) 900-0947 (800) 900-8654 Fax  
 info@nexusvalve.com www.nexusvalve.com

**Effective Date:** August 20, 2021

## ULTRAMBF™

- Open the valve to the proper setting.
- Check the pressure drop across the pressure testports and verify the GPM on the flow chart – adjust as needed to obtain the required flow.
- Set the memory stop at the new setting
  1. Remove the center screw in the handle.
  2. With a flat blade screwdriver, turn the inner stem travel stopper screw clockwise until it stops.
  3. Replace the center screw.
  4. The valve may now be closed as an isolation valve and opened back to the preset setting and not beyond.
  5. Reverse the memory stop setting instructions should additional commissioning changes be required.

### Maintenance

- The UltraMBF™ does not require maintenance under normal operating conditions.
- It is recommended to visually inspect products on regular intervals.

### Flow Charts & Calculators



Full scale flow charts can be obtained in the Nexus Valve Products Catalog as well as on-line at [www.nexusvalve.com](http://www.nexusvalve.com).

#### Basic Flow Calculator

**Cv Values for UltraMB Handle Turns**

Turns	MB-0250	MB-0300	MB-0400	MB-0500	MB-0600
	Valve Sizes:				
	2-1/2"	3"	4"	5"	6"
0.5	7.4	7.0	13.7	7.5	30.9
1.0	11.1	14.9	34.1	12.0	39.7
1.5	20.7	33.4	66.5	N/A	N/A
2.0	49.2	58.7	93.0	22.5	81.7
2.5	68.4	77.2	117.2	N/A	N/A
3.0	79.9	8.3	133.5	100.6	183.1
3.5	88.6	87.7	N/A	N/A	N/A
4.0	92.7	92.8	152.3	146.0	254.9
4.5	96.0	N/A	N/A	N/A	N/A
5.0	99.1	107.6	162.3	183.9	320.6
6.0	110.0	118.1	171.5	215.3	350.8
7.0	N/A	129.6	179.6	234.0	379.2
8.0	N/A	N/A	N/A	252.3	422
9.0	N/A	N/A	N/A	268.7	429.4
10.0	N/A	N/A	N/A	287.6	450.6
11.0	N/A	N/A	N/A	300.1	N/A
12.0	N/A	N/A	N/A	311.0	N/A
15.0	N/A	N/A	N/A	N/A	563.1

#### How to calculate the Flow through UltraMB using: Cv values

1. Select column MB-0250, MB-0300, MB-0400, MB-0500, MB-0600 for the valve being used
2. Read the Handle Turns counter on the valve
3. Scan the MB column for your valve and regard the Cv value for your turns
4. Use the following equations to calculate flow:

If PSID is in pounds/square inch

$$GPM = Cv \cdot \sqrt{\Delta P_{PSI}}$$

If PSID is in inches of Water

$$GPM = \sqrt{\Delta P_{inH_2O}} \cdot Cv / 5.3$$

#### How to determine UltraMB Handle Turns using: GPM and Pressure Differential (ΔP)

1. If GPM and required pressure drop is known, calculate the required Cv using the following equations:

If PSID is in pounds/square inch

$$Cv = GPM / \sqrt{\Delta P_{PSI}}$$

If PSID is in inches of Water

$$Cv = GPM \cdot 5.3 / \sqrt{\Delta P_{inH_2O}}$$

2. Locate Column for Valve being used
3. Scan down column until closest Cv to required is located
4. Read Turn number in first column

**Nexus Valve, Inc.**

9982 E. 121<sup>st</sup> Street

Fishers, IN 46037

(888) 900-0947 (800) 900-8654 Fax

info@nexusvalve.com www.nexusvalve.com

**Effective Date:** August 20, 2021

## ULTRAMBF™

### Nomograph Calculator

How to use the Nomograph to find the correct handle setting for your application:

1. Find the required GPM on the GPM Scale (example: 200 GPM - Point A on Nomograph)
2. Draw a line from the GPM value to the required differential pressure on the In H2O scale (example: 70 In H2O - Point B on Nomograph)
3. Note where the straight line crosses the Cv scale (example: Point C or approximately 150)
4. From the intersected point on the Cv scale draw a horizontal line through the MB valve scale (example: Point D on MB-0500 or slightly less than 4 turns)

How to use the Nomograph to find GPM:

1. Find your MB scale on the Nomograph (example: MB-0300)
2. Locate the turn setting for the valve (example: handle set at 1.5 turns - Point E on the Nomograph)
3. Draw a horizontal line from the turns setting to the Cv scale (example: line E-F, read Cv of 34)
4. Draw a line from the In H2O value on the In H2O scale through the located Cv value (example: line G-F for a In H2O of 50)
5. Continue the straight line (shown in red) until it intersects with the GPM scale (example: line F-H)
6. Read the GPM value on the GPM Scale (example: GPM equal approximately 43 GPM - Point H)

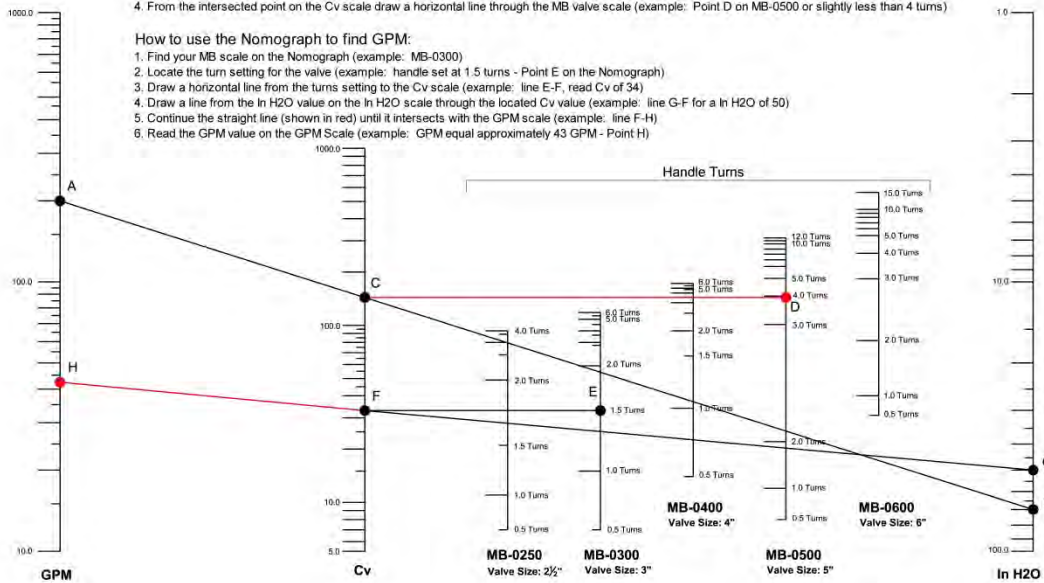

### MBF Flow Chart 2½"

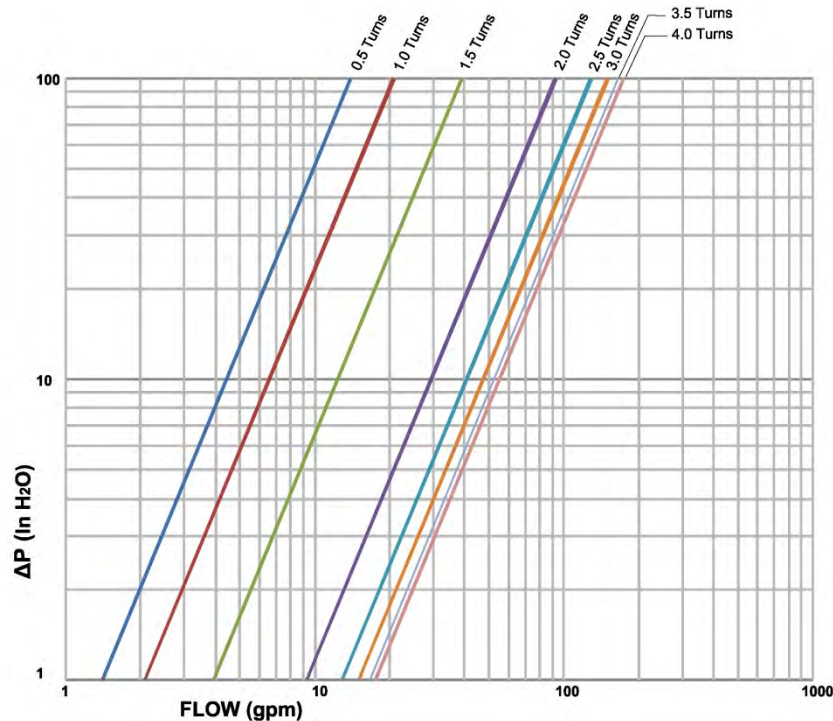

**Nexus Valve, Inc.**  
 9982 E. 121<sup>st</sup> Street  
 Fishers, IN 46037  
 (888) 900-0947 (800) 900-8654 Fax  
 info@nexusvalve.com www.nexusvalve.com

**Effective Date:** August 20, 2021

## ULTRAMBF™

**MBF Flow Chart 3"**

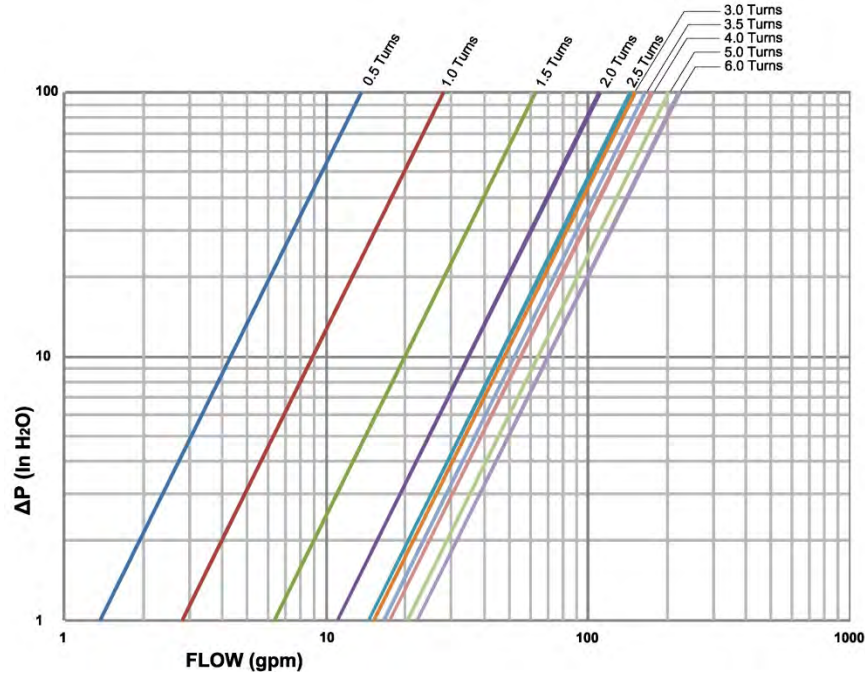

**MBF Flow Chart 4"**

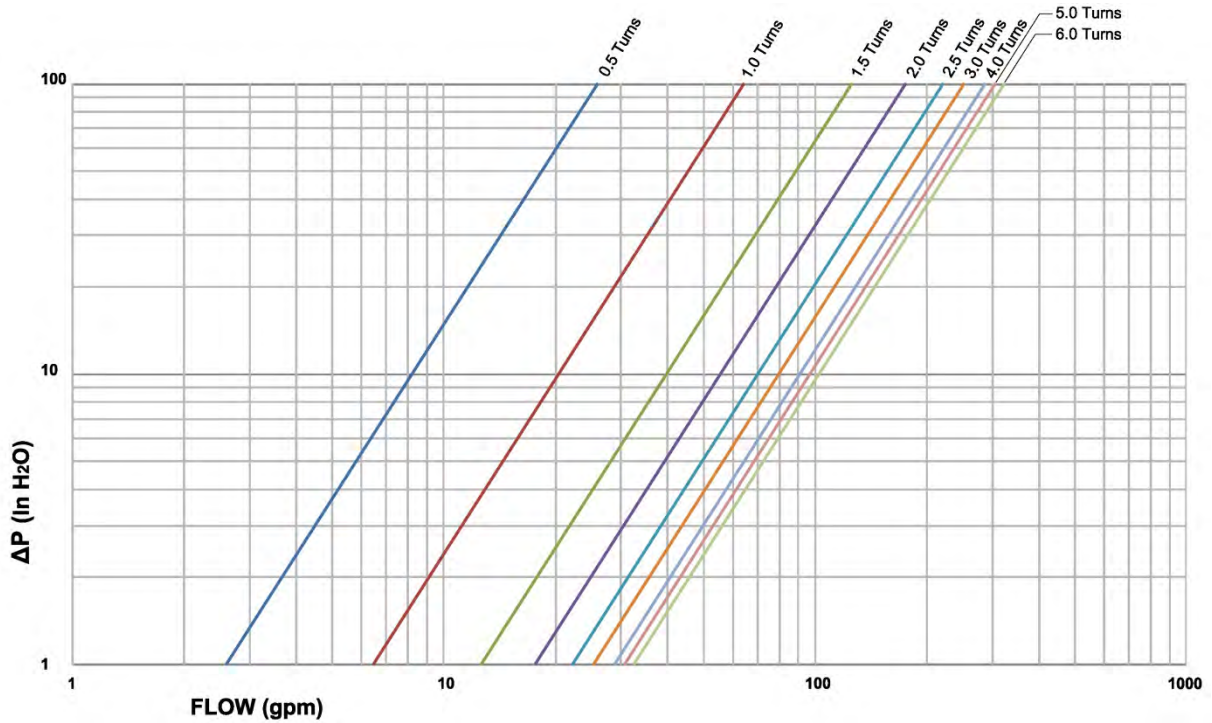

**Nexus Valve, Inc.**  
 9982 E. 121<sup>st</sup> Street  
 Fishers, IN 46037  
 (888) 900-0947 (800) 900-8654 Fax  
 info@nexusvalve.com www.nexusvalve.com

**Effective Date:** August 20, 2021

## ULTRAMBF™

**MBF Flow Chart 5"**

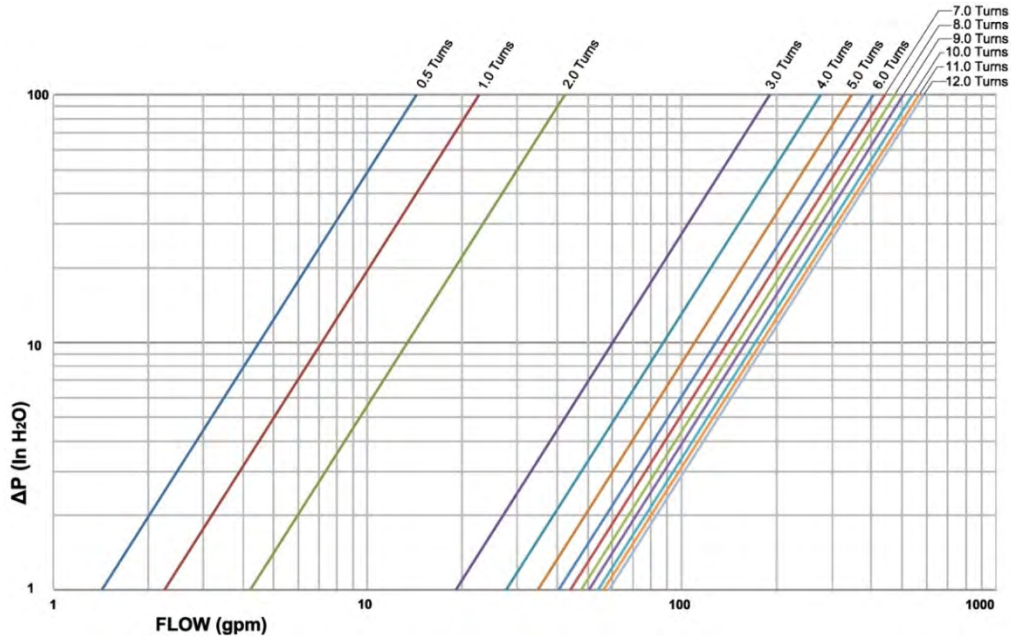

**MBF Flow Chart 6"**

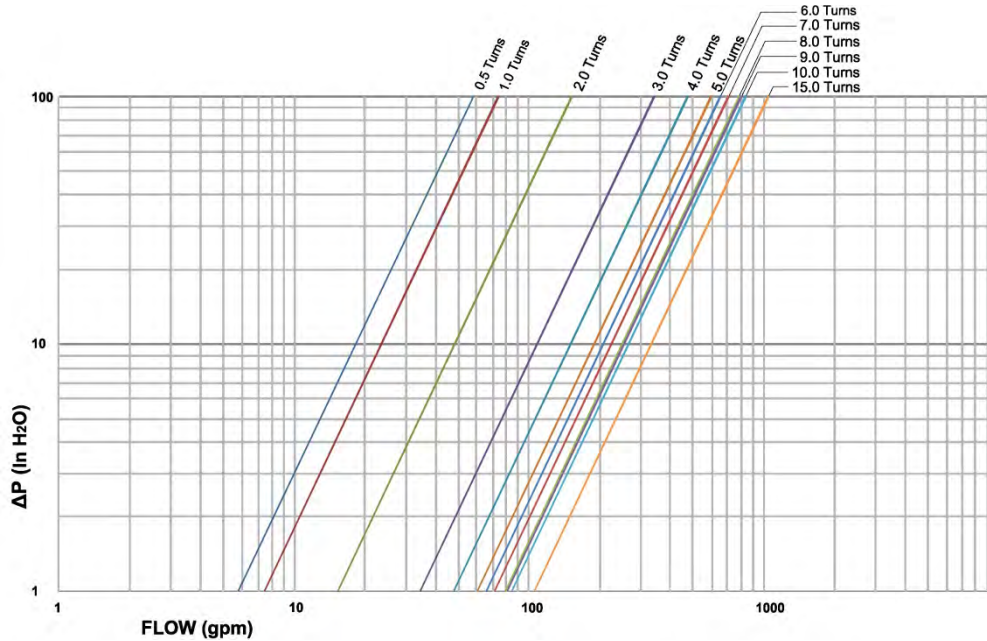

**Nexus Valve, Inc.**  
 9982 E. 121<sup>st</sup> Street  
 Fishers, IN 46037  
 (888) 900-0947 (800) 900-8654 Fax  
 info@nexusvalve.com www.nexusvalve.com

**Effective Date:** August 20, 2021

## NEXUS VENTURI – MODEL NV™

### Nexus Venturi – Model NV™

The Nexus Venturi is a manually adjustable balancing valve and metering station which uses a precision venturi tube for accurately measuring differential pressure.



Please note that the Nexus Venturi accessories may be packaged separately to avoid damage during shipping. Accessory packages include all plugs necessary to install in any unused ports. Valve bodies are packaged separately and identified appropriately.

### Models



### General Installation Notes

- An arrow on the label indicates the flow direction of the valve – the NV™ will not work properly if installed backwards.
- Installation of a y-strainer is recommended upstream of any control valve or balancing device.
- To achieve maximum performance, the elimination of air in the fluid is required.
- The NV™ may be shipped with a butterfly valve – the butterfly valve must be installed downstream from the NV™ and may be attached directly to the flange of the NV™.
- Valves should be installed with the disc in the closed position to prevent possible damage to disc edge. Flanged models use standard ANSI 125# class flanges (also mates to 150# class flanges). Assembly may be accomplished with standard gaskets and hardware. Butterfly valves should be checked for free unobstructed disc movement.

**Nexus Valve, Inc.**  
9982 E. 121<sup>st</sup> Street  
Fishers, IN 46037  
(888) 900-0947 (800) 900-8654 Fax  
info@nexusvalve.com www.nexusvalve.com

**Effective Date:** August 20, 2021

---

## NEXUS VENTURI – MODEL NV™

---



### Straight Run Requirements

The NV™ requires a minimum of five (5) straight upstream pipe diameters and zero (0) downstream. If a pump is installed immediately in front of the NV™, there is a requirement of ten (10) straight upstream pipe diameters.

### Adjusting & Balancing

- The NV™ should be adjusted in the field by an experienced balance contractor.
- The desired flow rate is set by slowly adjusting the supplied butterfly valve until the differential pressure reading across the pressure and temperature test plugs reaches the desired pressure drop.
- Multiple passes are usually required to properly balance the system.
- Once this is achieved, lock the memory stop, which is located on the top works of the butterfly valve handle.



The readout instrument should be located below the NV™. This prevents air entrapment in the instrument lines. Instrument lines should be properly sloped down ½” per foot with no high points that may cause air entrapment. If this is not possible, air vents must be placed at any high points in the piping. To ensure the quality of the reading, the best orientation of the TwinTube™ may be vertically down.

### Meter Kits

A DP meter kit, such as Nexus #MKM models, must be used to measure the differential pressure. If using a Nexus Valve meter kit, connect the red hose to the high-pressure port, typically indicated by a red cap, and the blue hose to the low-pressure port, typically indicated by a green cap.



Refer to page 69 for meter kit operating instructions.  
Refer to page 9 for bolting & tightening specifications.  
Refer to page 10 for valve identification.

### Maintenance

- The NV™ does not require maintenance under normal operating conditions.
- It is recommended to visually inspect products on regular intervals.

**Nexus Valve, Inc.**  
 9982 E. 121<sup>st</sup> Street  
 Fishers, IN 46037  
 (888) 900-0947 (800) 900-8654 Fax  
 info@nexusvalve.com www.nexusvalve.com

**Effective Date:** August 20, 2021

## NEXUS VENTURI – MODEL NV™

### Nexus Venturi Flow Chart



Full scale flow charts can be obtained in the Nexus Valve Products Catalog as well as on-line at [www.nexusvalve.com](http://www.nexusvalve.com).

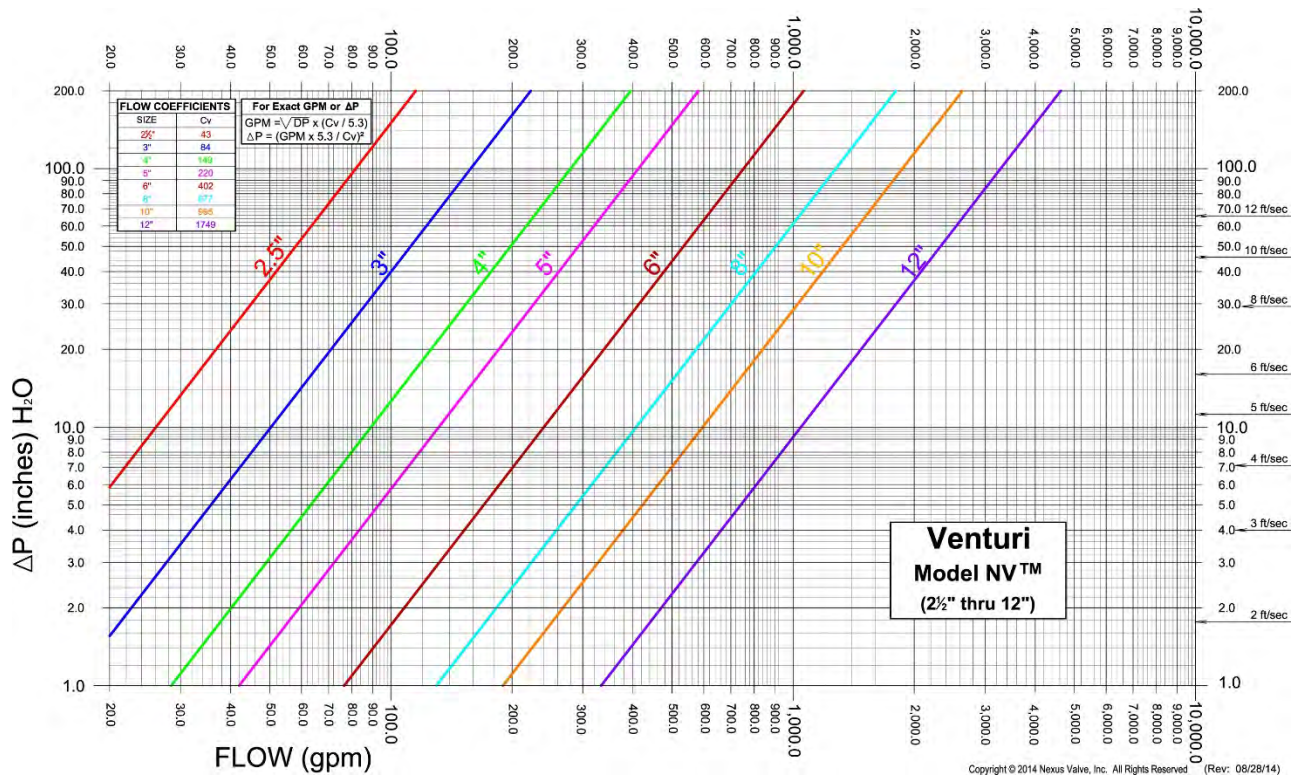

**Nexus Valve, Inc.**  
9982 E. 121<sup>st</sup> Street  
Fishers, IN 46037  
(888) 900-0947 (800) 900-8654 Fax  
info@nexusvalve.com www.nexusvalve.com

**Effective Date:** August 20, 2021

## STRAINEX™

### Strainex™

#### General

Strainex™ is a cast iron, flanged pipeline y-strainer and metering station. Accessories for the Strainex™ are packaged separately to avoid damage during shipping.

#### Models



#### Installation Notes

- Strainex™ should be installed on the supply side of a coil or wherever a pipeline strainer is required, and can be in horizontal and vertical planes.
- Each Strainex™ is identified with a flow direction arrow. It is imperative that the flow arrow points in the direction of flow.



Refer to page 9 for bolting and tightening specifications.  
Refer to page 10 for valve identification.



**Nexus Valve, Inc.**  
 9982 E. 121<sup>st</sup> Street  
 Fishers, IN 46037  
 (888) 900-0947 (800) 900-8654 Fax  
 info@nexusvalve.com www.nexusvalve.com

**Effective Date:** August 20, 2021

## STRAINEX™

- As allowed by the flange pattern, the Strainex™ body and/or butterfly valve may be rotated to any orientation in the pipeline. However, it is recommended that the drain valve be installed as in the picture below to allow accumulated dirt to be removed. Valves should be installed with the disc in the closed position to prevent possible damage to disc edge. Flanged models use standard ANSI 125# class B flanges (also mates to 150# class flanges). Assembly may be accomplished with standard gaskets and hardware. Butterfly valves should be checked for free unobstructed disc movement.

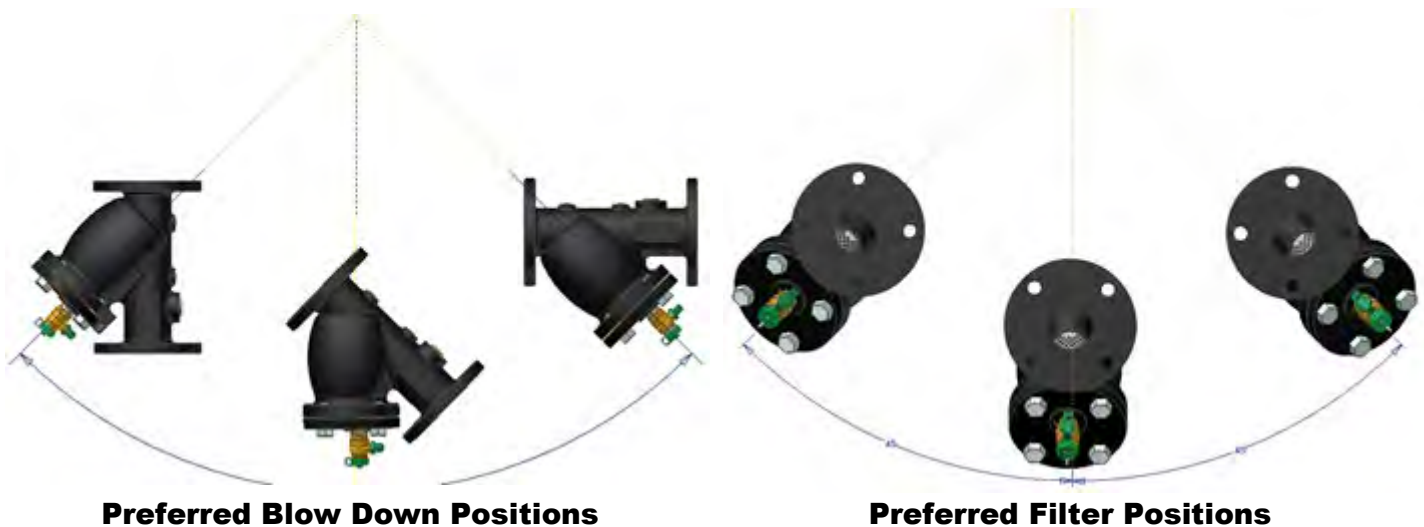

### Maintenance

- If Strainex's™ pressure drop becomes excessive, accumulated dirt should be blown down through the blowdown/drain valve to a drain.
- The Strainex™ may require annual or periodic maintenance.
- It is recommended to visually inspect products on regular intervals.

### Strainer Screen Maintenance / Replacement

- Shut inlet and outlet isolation valves. Drain coil. Remove access plate on the bottom of the Strainex™.
- The screen may be removed without disrupting the piping. Remove screen by hand, no tools are necessary.
- Install new or clean screen, replace access plate and gasket. Bolt plate onto valve body. Slowly open isolation valve. Purge air and check for leaks. Use of a replacement gasket is recommended.

**Nexus Valve, Inc.**  
 9982 E. 121<sup>st</sup> Street  
 Fishers, IN 46037  
 (888) 900-0947 (800) 900-8654 Fax  
 info@nexusvalve.com www.nexusvalve.com

**Effective Date:** August 20, 2021

## ULTRAY™

### UltraY™

#### General

The UltraY™ is a combination y-strainer, ball valve, and union. In addition to being used as a strainer, it can be used to isolate hydronic equipment for repairs and/or to drain the system.

#### Installation Notes

- UltraY™ can be installed on the supply side of the coil or wherever a y-strainer is required, and can be installed horizontally or vertically.
- When installing the UltraY™, space around the valve must be provided for port access, rotation of the handle, and possible cleaning of the strainer element.
- A blowdown/drain is recommended on the UltraY™ to allow accumulated dirt to be removed.
- After use, **CLOSE** the blowdown / drain valve by turning the handle perpendicular to flow. The cap **IS NOT** designed to contain flow.
- UltraY™ does not need any straight-run requirements for either inlet or outlet.

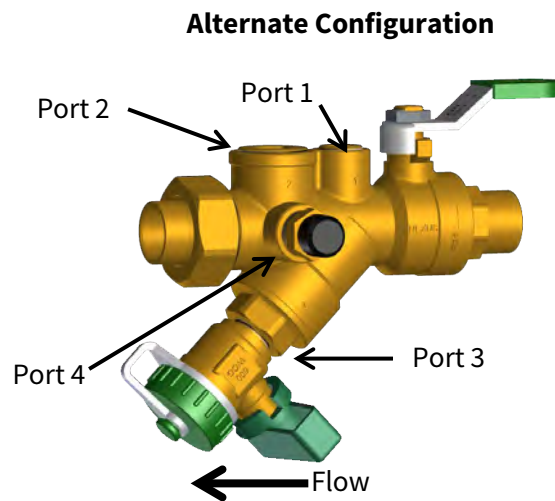
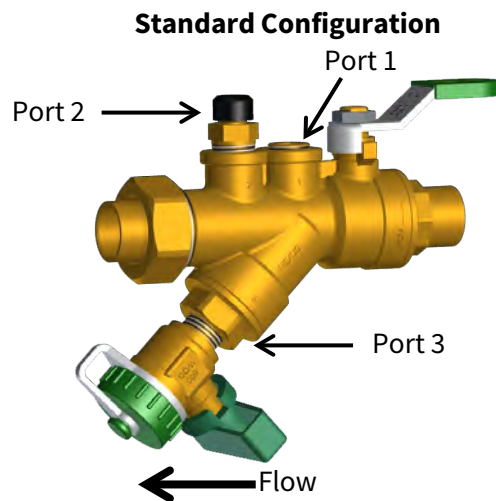

Refer to page 2 for installation procedure.  
 Refer to page 10 for valve identification.

**Nexus Valve, Inc.**  
9982 E. 121<sup>st</sup> Street  
Fishers, IN 46037  
(888) 900-0947 (800) 900-8654 Fax  
info@nexusvalve.com www.nexusvalve.com

**Effective Date:** August 20, 2021

## ULTRAY™

### Models YSS and YSF

Models YSS and YSF are part of the UltraY™ family but do not include all of the same features as the UltraY™.

**THESE VALVES DO NOT MEET LEAD FREE / LOW LEAD REQUIREMENTS.**



Refer to page 2 for installation procedure.  
Refer to page 10 for valve identification.



**DO NOT OVERTIGHTEN THE THREADED CONNECTIONS! EXCESSIVE TIGHTENING WILL RESULT IN CRACKED VALVES RESULTING IN LEAKS AND CATASTROPHIC FAILURE.**

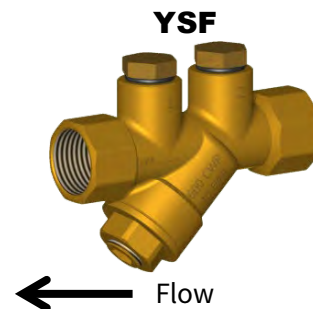
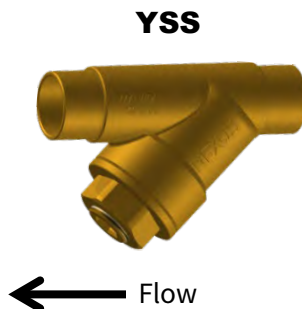

### Maintenance

- It is recommended to visually inspect products on regular intervals.

### Strainer Screen Maintenance / Replacement

- Close inlet and outlet isolation valves. Drain the coil. Remove chamber cap on the bottom of the UltraY™.
- The screen may be removed without disrupting the piping. Remove screen by hand, no tools are necessary.
- Replace screen. Replace FKM O-Ring on the chamber cap.
- Replace chamber cap onto valve body, tighten firmly using Wrenches # 13/16", # 1 1/16", or # 32 mm, depending on the valve size.
- Slowly open isolation valve.
- Purge air and check for leaks.
- Periodic maintenance is required for filters. Failure to properly maintain filter element may cause permanent damage to the valve.
- A 20 mesh screen is standard. A 40 mesh screen is optional.

**Nexus Valve, Inc.**  
9982 E. 121<sup>st</sup> Street  
Fishers, IN 46037  
(888) 900-0947 (800) 900-8654 Fax  
info@nexusvalve.com www.nexusvalve.com

**Effective Date:** August 20, 2021

---

---

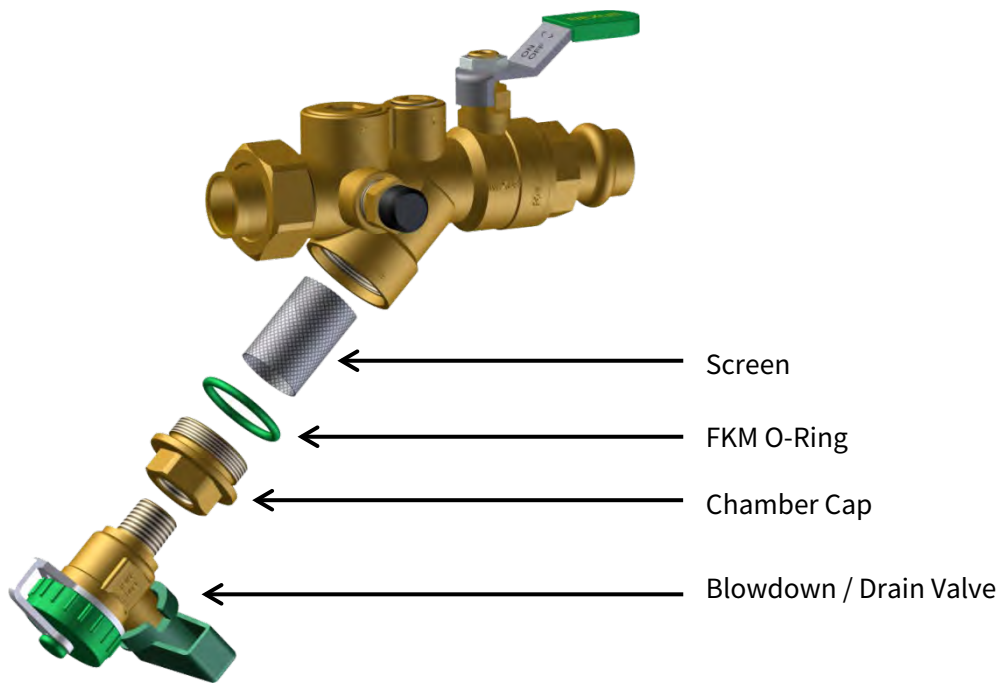
**ULTRAY™**

**Nexus Valve, Inc.**  
9982 E. 121<sup>st</sup> Street  
Fishers, IN 46037  
(888) 900-0947 (800) 900-8654 Fax  
info@nexusvalve.com www.nexusvalve.com

**Effective Date:** August 20, 2021

## ULTRAX™

### UltraX™

#### General

UltraX™ is a combination ball valve and union with three (3) 1/4" accessory ports.

#### Installation Notes

- When installing the UltraX™, space around the valve must be provided for port access and rotation of the handle.
- UltraX™ can be used to isolate hydronic equipment for repairs and/or to drain the system.



Refer to page 2 for installation procedure.  
Refer to page 10 for valve identification.

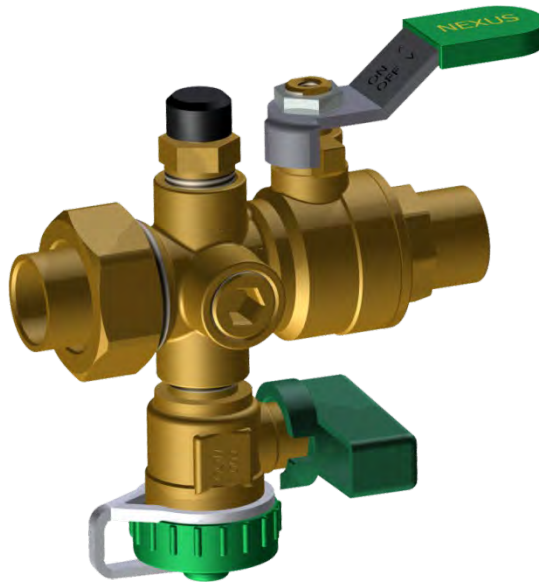

#### Maintenance

- UltraX™ does not require maintenance under normal operating conditions.
- It is recommended to visually inspect products on regular intervals.

**Nexus Valve, Inc.**  
9982 E. 121<sup>st</sup> Street  
Fishers, IN 46037  
(888) 900-0947 (800) 900-8654 Fax  
info@nexusvalve.com www.nexusvalve.com

**Effective Date:** August 20, 2021

## ULTRANXP™

### UltraNXP™

#### General

The UltraNXP™ is a combination ball valve and union with one (1) 1/4" accessory port.

#### Installation Notes

- When installing the UltraNXP™, space around the valve must be provided for port access, rotation of the handle.
- UltraNXP™ can be used to isolate hydronic equipment for repairs and/or instrumentation.



Refer to page 2 for installation procedure.  
Refer to page 10 for valve identification.

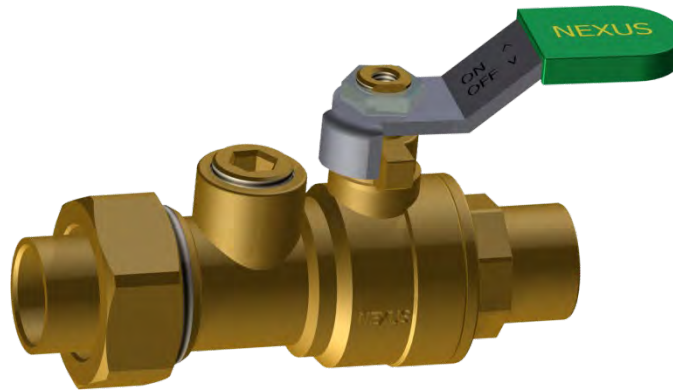

#### Maintenance

- UltraNXP™ does not require maintenance under normal operating conditions.
- It is recommended to visually inspect products on regular intervals.

**Nexus Valve, Inc.**  
9982 E. 121<sup>st</sup> Street  
Fishers, IN 46037  
(888) 900-0947 (800) 900-8654 Fax  
info@nexusvalve.com www.nexusvalve.com

**Effective Date:** August 20, 2021

## ULTRAU™

### UltraU™

#### General

UltraU™ Unions can be used for easy removal of hydronic equipment for repairs and/or to drain the system.

#### Installation Notes

- UltraU™ Union may be installed anywhere a union is required.
- When installing the UltraU™, space around the valve must be provided for port access.
- When a Manual/Automatic or other accessories to vent air is included, it must face upward, and the blowdown/drain valve downward.



Refer to page 2 for installation procedure.  
Refer to page 10 for valve identification.

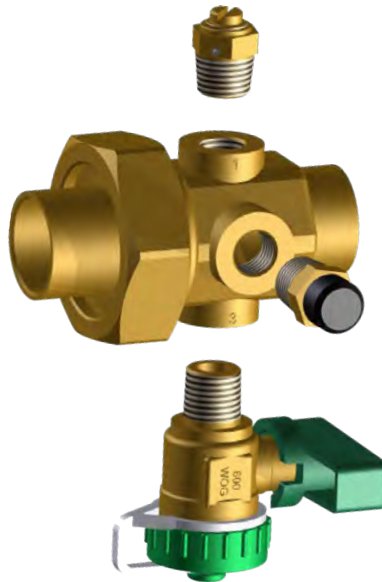

#### Maintenance

- UltraU™ does not require maintenance under normal operating conditions.
- It is recommended to visually inspect products on regular intervals.

**Nexus Valve, Inc.**  
 9982 E. 121<sup>st</sup> Street  
 Fishers, IN 46037  
 (888) 900-0947 (800) 900-8654 Fax  
 info@nexusvalve.com www.nexusvalve.com

**Effective Date:** August 20, 2021

## VALVES FOR ACTUATORS (UMA / MBA)

### Valves for Actuators (UMA / MBA)

#### General Information

The UltraMatic™ UMA Actuated Control Valve is a pressure independent automatic flow limiting valve with a equal percentage ball valve and an electrically controled actuator. The UltraMB™ MBA Actuated Control Valve is a pressure dependent manually adjusted flow limiting valve with an equal percentage ball valve and an electrically controlled actuator.

#### Models

##### UMA (UltraMatic™ for Actuators)

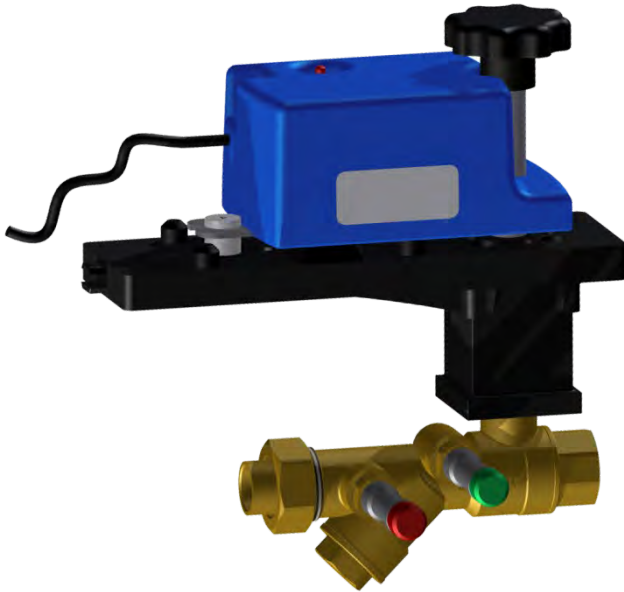

See page 11 for more information on UltraMatic™.

##### MBA (UltraMB™ for Actuators)

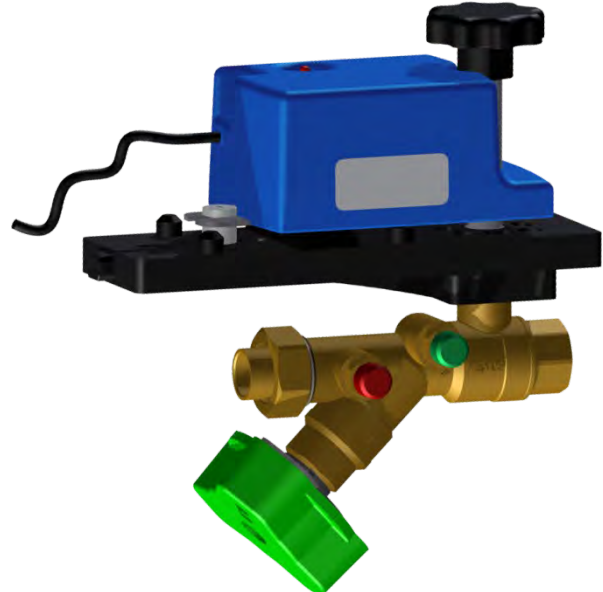

See page 26 for more information on UltraMB™.

#### Installation Notes

- The actuated valve may be mounted horizontally or vertically
- When mounting horizontally the actuator should be on top of the pipe within 45° of pure vertical
- Direction of flow:
- On supply side applications the ball valve is the first element the water should pass through.
- On return side applications the ball valve is the last element the water should pass through.
- Straight run requirements are not typically required for the Ultramatic UMA, however changes in pipe diameters before and after the valve may impact stability of pressure drop readings in both UMA and MBA.



**Nexus Valve, Inc.**  
9982 E. 121<sup>st</sup> Street  
Fishers, IN 46037  
(888) 900-0947 (800) 900-8654 Fax  
info@nexusvalve.com www.nexusvalve.com

**Effective Date:** August 20, 2021

## VALVES FOR ACTUATORS (UMA / MBA)

- Installation of a y-strainer upstream from the control valve is recommended for life and performance of the Model UMA and MBA.



Refer to page 2 for installation procedure.  
Refer to page 10 for valve identification

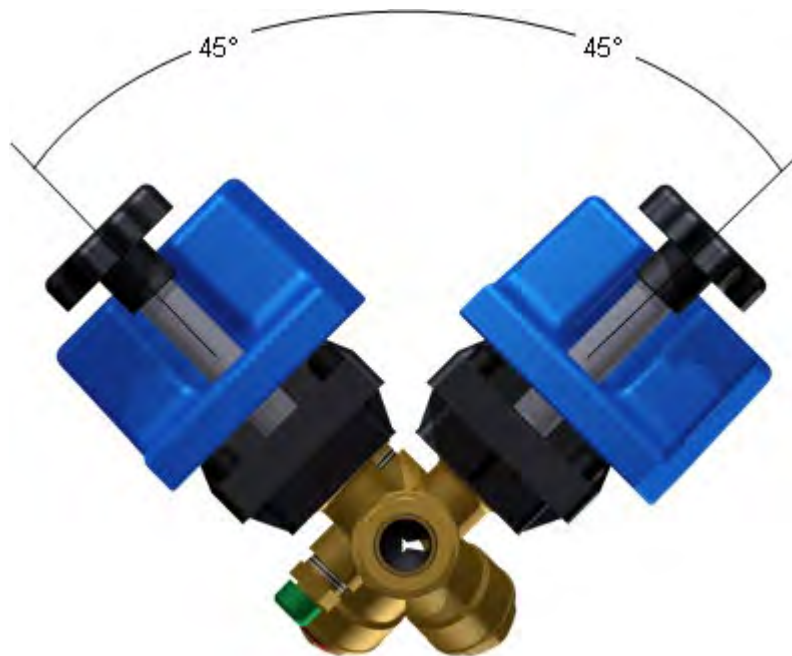

### Accessories

- The Ultramatic Models UMA and MBA comes equipped with two standard PT test plugs; port 1 is the high pressure port and port 2 is the low pressure port.
- The Ultramatic Model UMA may be outfitted with various pressure independent flow limiting cartridges.
- The Models UMA and MBA comes standard with a full port ball valve, but may be configured with an equal percentage ball valve. The hang tag on the valve body will be marked with the appropriate Cv for the equal percentage ball valve.
- Actuator mounting brackets – standard or extended.
- ISO F03 Mounting pad with square 9 mm valve stem.

### Connecting an Actuator to UMA

- Important considerations when selecting an Actuator for the Nexus Valve UMA / MBA

**Nexus Valve, Inc.**9982 E. 121<sup>st</sup> Street

Fishers, IN 46037

(888) 900-0947 (800) 900-8654 Fax

info@nexusvalve.com www.nexusvalve.com

**Effective Date:** August 20, 2021

---

## VALVES FOR ACTUATORS (UMA / MBA)

---

- Check the Actuator Matrix in the Nexus Valve TCV Catalog for actuators selected for mounting on our valve. If the matrix does not meet your criteria ensure the following when selecting an alternate actuator:
- Output of actuator must be greater than 18 inch lbs
- Actuator must accept a ½ shaft
- Actuator must mount to the Nexus Valve universal mounting bracket
- Actuator must have flat bottom for mounting to the universal mounting bracket
- Actuator must have a “T” slot in the bottom to accept a mounting “T” anchor to secure actuator the universal mounting bracket.
- ACTUATOR MUST BE SET FOR CLOCKWISE FROM NORMALLY CLOSED POSITION TO FULLY OPEN
- There are two bracket styles – normal and extended for use with insulation. An Allen wrench for a 10-32 socket head cap screw is required to attach the bracket to the valve. The normal bracket assembly requires the universal bracket and four 3/8” long 10-32 socket head cap screws.
- The extended assembly requires the universal bracket the extension kit and four 1-3/4” long 10-32 socket head cap screws.
- After selecting the proper shaft (see “Suggestions for shaft selection” below) for the installation, insert shaft through the ½” diameter bracket hole, align the flats with the diagonal cut on the valve stem and press the bracket over the valve mounting pad. The universal mounting bracket may be aligned in four 90° positions around the valve stem. Tighten the socket head cap screws to 25 inch lbs.
- Select correct shaft for application from four Nexus Valve options, shaft must be long enough to pass through bracket and completely through actuator coupling.
- Suggestions for shaft selection – key dimension is actuator thickness (bottom of actuator to top of shaft coupling).

**For normal bracket installation.**

- Actuator thickness less than 1.8“- use shaft UNS-YA1.
- Actuator greater than 1.8” and less than 3.2” - use shaft UNSXS-YA1.

**For extended bracket installation**

- Actuator thickness less than 1.8” - use shaft UNSX-YA1.
- Actuator greater than 1.8” and less than 3.2” - use shaft UNSXL-YA1.
- Actuator Anchors – Nexus Valve has five alternative anchors. These anchors are used to secure the “rear end” of the actuator from moving when actuator is activated.
- These anchors are designed for the pre-selected actuators supplied by Nexus Valve, but may work with other actuators.
- Anchors should be assembled through the bottom of the bracket with a washer, a locking washer and a 3/8” long 10-32 socket head cap screw. Socket head cap screw should be tightened to 25 in lbs once the anchor is slide into the T slot on the bottom of the actuator.
- If the Nexus Valve anchors do not fit your actuator, then an alternative anchoring device will need to be fabricated. You may be able to use “off the shelf” screws and nuts. It is important that the anchor secure the actuator squarely on the bracket, does not “bend” the actuator over the bosses on the bracket, and prevents the actuator from moving when actuator is activated. In using non-standard anchors, it is imperative that the

**Nexus Valve, Inc.**  
9982 E. 121<sup>st</sup> Street  
Fishers, IN 46037  
(888) 900-0947 (800) 900-8654 Fax  
info@nexusvalve.com www.nexusvalve.com

**Effective Date:** August 20, 2021

---

## VALVES FOR ACTUATORS (UMA / MBA)

---

anchor does not bind the actuator and prevent free rotation of the ball valve. Failure to ensure free rotation of the ball valve will induce pre-mature failure of the valve stem seals.

- Wiring the actuator – follow actuator manufactures data sheet for proper rotation of ball valve.  
NOTE: Ensure actuator is set for normally closed with counter-clock-wise rotation to open valve. If rotation is incorrect, user will not receive benefits of the characterized v port.

### Operation

When both the mechanical and electrical connections are made to the manufacture’s requirements cycle the actuator to ensure:

- proper rotation
- complete cycling of the actuator and ball valve
- free rotation
- no binding of the shaft and actuator
- no motion of the actuator on the universal bracket
- if actuator is spring loaded, ensure actuator cycles correctly to stop position when power is removed

### Maintenance

#### Valve Maintenance

Valve should be examined periodically to ensure no leaks or indications of valve damage

#### Actuator Maintenance

- Periodic review that connections to the valve are tight, ensure the actuator is not moving on the bracket and the shaft is tightly connected to the actuator coupling.
- Follow actuator manufacturer’s maintenance procedures.

**Nexus Valve, Inc.**  
 9982 E. 121<sup>st</sup> Street  
 Fishers, IN 46037  
 (888) 900-0947 (800) 900-8654 Fax  
 info@nexusvalve.com www.nexusvalve.com

**Effective Date:** August 20, 2021

## ULTRA BK™ BYPASS KITS

### Ultra BK™ Bypass Kits

#### General

The UltraBK™ bypass and flush kit is a universal product that can be used to provide the best terminal component protection during system flushing.

#### Models

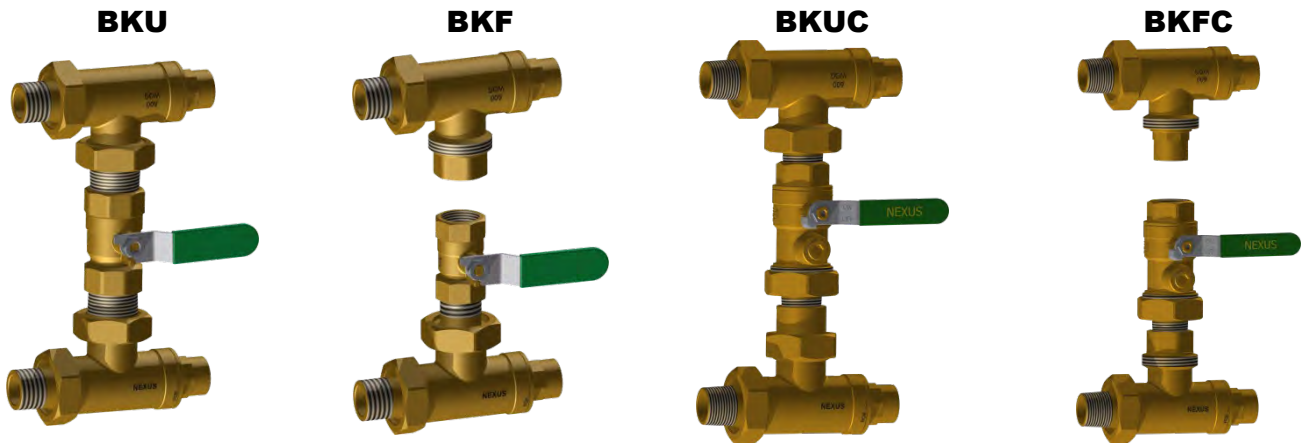

#### Installation Notes

- UltraBK™ does not typically require any straight pipe runs up or downstream.
- When installing UltraBK™, space around the valve must be provided for rotation of the handle
- UltraBK™ can be installed in horizontal and vertical planes.



Refer to page 2 for installation procedure.  
 Refer to page 10 for valve identification.  
 Refer to page 61 for information about the SBV standard ball valve.  
 Refer to page 52 for information about the NXP ball valve.

#### Maintenance

- UltraBK™ does not require maintenance under normal operating conditions.
- It is recommended to visually inspect products on regular intervals.

**Nexus Valve, Inc.**  
 9982 E. 121<sup>st</sup> Street  
 Fishers, IN 46037  
 (888) 900-0947 (800) 900-8654 Fax  
 info@nexusvalve.com www.nexusvalve.com

**Effective Date:** August 20, 2021

## ULTRA BK™ BYPASS KITS

### Operation Flushing

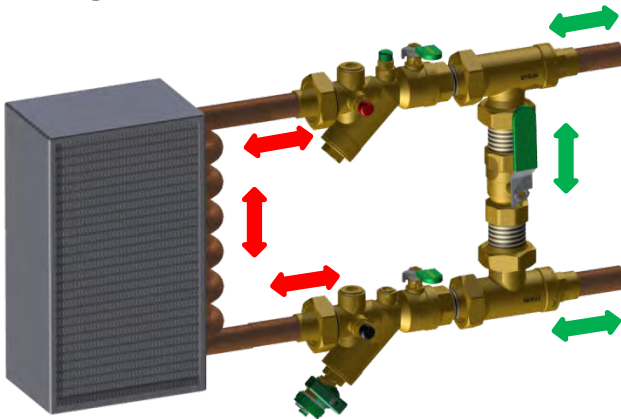

1. Close the supply side valve .
2. Close the return side valve.
3. Open the bypass valve.
4. Repeat on all terminal units.
5. System is now ready for flushing.

### Standard Operation

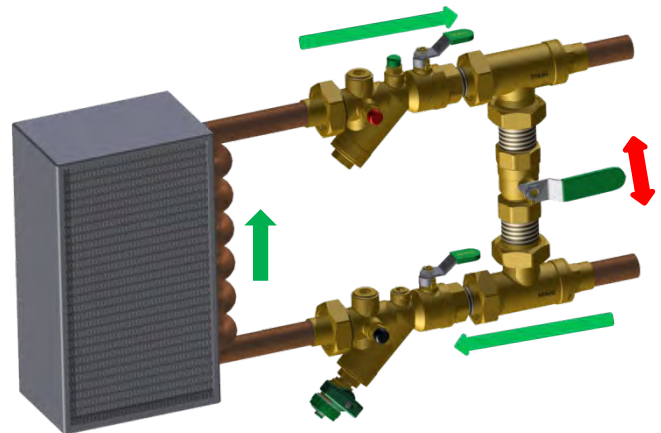

1. Close the bypass valve.
2. Open the supply side valve.
3. Open air vent to purge any free air from system.  
Close vent when air is purged.
4. Open the return side valve.
5. Repeat on all terminal units.
6. System is now ready for operation.

**Nexus Valve, Inc.**  
9982 E. 121<sup>st</sup> Street  
Fishers, IN 46037  
(888) 900-0947 (800) 900-8654 Fax  
info@nexusvalve.com www.nexusvalve.com

**Effective Date:** August 20, 2021

## ULTRAT™

### UltraT™

#### General

The UltraT™ is a universal tee fitting that can be used for a multitude of applications. It is available with either 1 fixed end and 2 union ends or 2 fixed ends and 1 union end. See models below.

#### Models

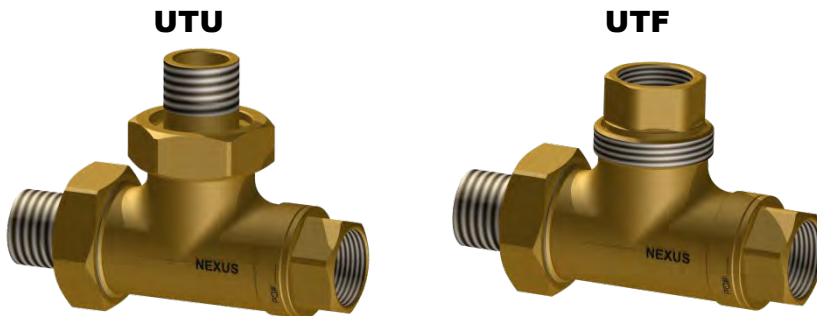

#### Installation Notes

- UltraT™ does not require any straight pipe runs up or downstream.
- UltraT™ can be installed in horizontal and vertical planes.



Refer to page 2 for installation procedure.  
Refer to page 10 for valve identification.

#### Maintenance

- UltraT™ does not require maintenance under normal operating conditions.
- It is recommended to visually inspect products on regular intervals.

**Nexus Valve, Inc.**  
9982 E. 121<sup>st</sup> Street  
Fishers, IN 46037  
(888) 900-0947 (800) 900-8654 Fax  
info@nexusvalve.com www.nexusvalve.com

**Effective Date:** August 20, 2021

---

## CONFIGUR-A-BALL

---

### Configur-A-Ball

#### General

Configur-A-Ball (CAB) is a fully configurable ball valve with multiple connection types that may be installed anywhere a general isolation valve is required.

#### Installation Notes

- CAB does not typically require any straight pipe runs up or downstream.
- When installing CAB, space around the valve must be provided for rotation of the handle.
- CAB can be installed in horizontal and vertical planes.



Refer to page 2 for installation procedure.  
Refer to page 10 for valve identification.

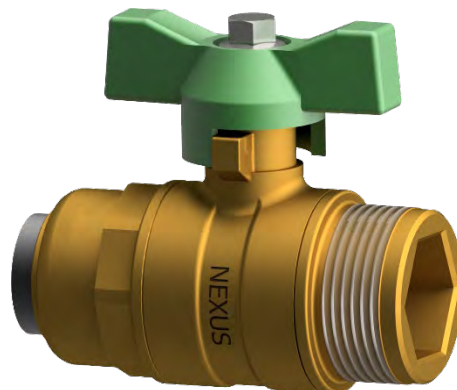

#### Maintenance

- CAB does not require maintenance under normal operating conditions.
- It is recommended to visually inspect products on regular intervals.

**Nexus Valve, Inc.**  
 9982 E. 121<sup>st</sup> Street  
 Fishers, IN 46037  
 (888) 900-0947 (800) 900-8654 Fax  
 info@nexusvalve.com www.nexusvalve.com

**Effective Date:** August 20, 2021

## NXU / NXS / NXH

### NXU / NXS / NXH

#### General

The UltraNX™ is a family of unique ball valves with a variety of connection types. A memory stop is also provided on all NX series valves. The NXU can be used anywhere a general isolation valve is required.

#### Models

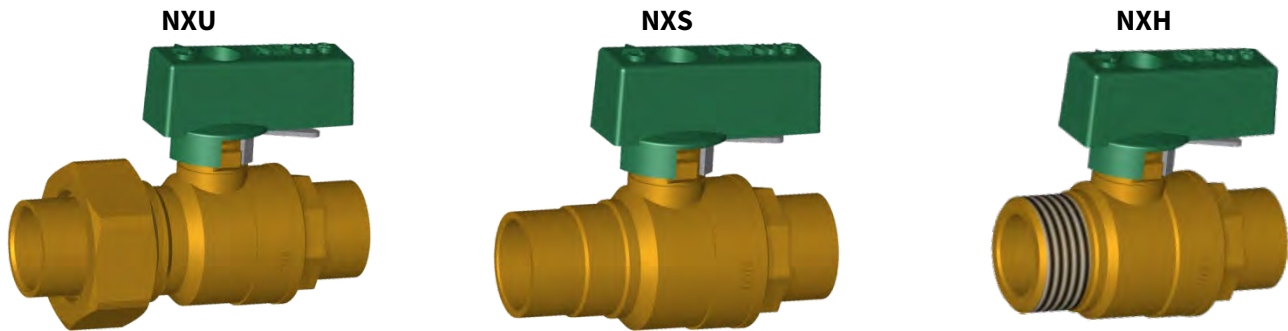

#### Installation Notes

- A memory stop is provided and can be adjusted using a Phillips screwdriver on the top of the handle.
- The UltraNXH™ is a combination ball valve with stainless steel braided hose connected at one end. This can be used for isolation of mechanical equipment where allowed.

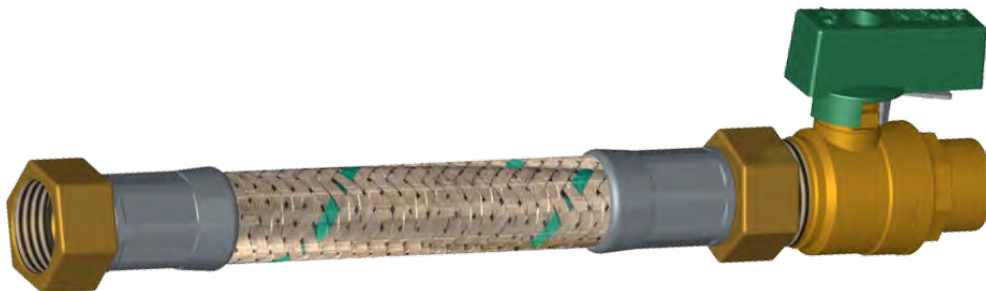

Refer to page 2 for installation procedure.  
 Refer to page 10 for valve identification.  
 Refer to page 63 for hose installation procedures.

#### Maintenance

- NXU and the NXH do not require maintenance under normal operating conditions.
- It is recommended to visually inspect products on regular intervals.



**Nexus Valve, Inc.**  
9982 E. 121<sup>st</sup> Street  
Fishers, IN 46037  
(888) 900-0947 (800) 900-8654 Fax  
info@nexusvalve.com www.nexusvalve.com

**Effective Date:** August 20, 2021

## ULTRAFLEX™

### UltraFlex™

#### General

Nexus UltraFlex™ hoses are specifically designed for trouble free long term use when properly installed in hydronic applications. UltraFlex™ hoses and associated pipe fittings are fabricated to meet demands of most normal temperatures, pressures, and fluids associated with most hydronic applications. Maximum pressure and temperature limits are stamped on one ferrule of each hose for easy identification.

#### Installation Instructions

- When installing flexible hoses, do not impart a twist or torque load upon the hose. Be careful when tightening the threaded connections. When tightening the female threaded nut of a hose, hold the ferrule stationary by hand while tightening the screw connections. **Male threaded connections do not swivel, hold the male fittings at the hexagonal shoulder provided at the base of the male connector when tightening.**



Be careful when tightening the threaded connections.



**Nexus Valve, Inc.**  
9982 E. 121<sup>st</sup> Street  
Fishers, IN 46037  
(888) 900-0947 (800) 900-8654 Fax  
info@nexusvalve.com www.nexusvalve.com

**Effective Date:** August 20, 2021

## ULTRAFLEX™

- Never install the hose in tension. The hose is made to hold internal pressure, not to act as a means of support. Always allow an extra 5% in actual hose length to allow for shrinkage when the hose is subjected to internal pressure.
- The rigid piping attached to flexible hose should be anchored immediately to the hose connection to avoid imposing piping support and vibration loads on the flexible hose.
- Avoid tight bends in the flexible hose. Tight bends can reduce the flow capacity of the hose, induce high pressure drops, and may lead to failure.



**Nexus Valve, Inc.**  
 9982 E. 121<sup>st</sup> Street  
 Fishers, IN 46037  
 (888) 900-0947 (800) 900-8654 Fax  
 info@nexusvalve.com www.nexusvalve.com

**Effective Date:** August 20, 2021

## ULTRAFLEX™

UltraFlex Allowing A Bend					
Size	Length (in)	A (in)	B (in)	R Min. Bend Radius (in)	C (max) Based on R
1/2"	12	1.6	0.9	3.5	114°
	18	1.6	0.9	3.5	180°
	24	1.6	0.9	3.5	180°
	36	1.6	0.9	3.5	180°
3/4"	12	2.2	1.4	3.5	79°
	18	2.2	1.4	3.5	176°
	24	2.2	1.4	3.5	180°
	36	2.2	1.4	3.5	180°
1"	12	2.7	1.4	4.3	50°
	18	2.7	1.4	4.3	130°
	24	2.7	1.4	4.3	180°
	36	2.7	1.4	4.3	180°
1-1/4"	18	3.5	1.8	5.1	82°
	24	3.5	1.8	5.1	149°
	36	3.5	1.8	5.1	180°
1-1/2"	18	4.2	2.0	7.1	45°
	24	4.2	2.0	7.1	93°
	36	4.2	2.0	7.1	180°
2"	18	5.1	2.2	9.4	20°
	24	5.1	2.2	9.4	56°
	36	5.1	2.2	9.4	129°

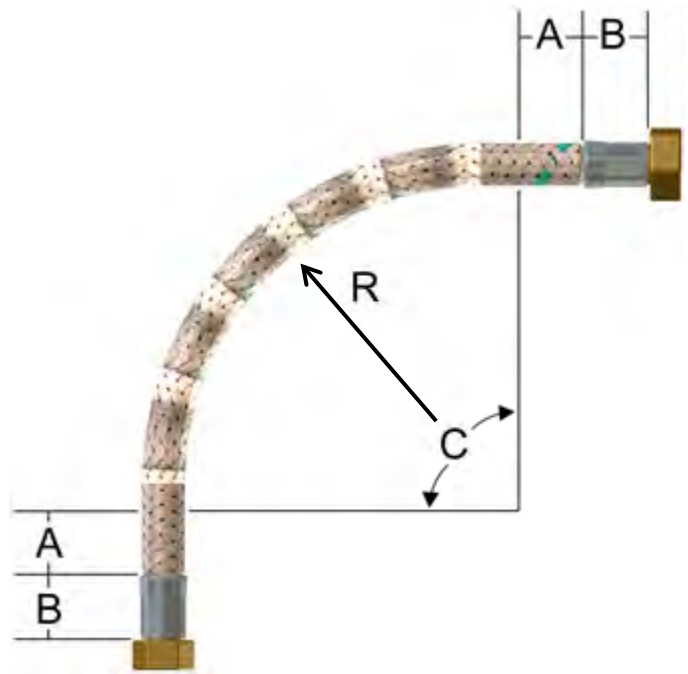

- The bend in a flexible hose should all be in one plane. Example; A hose may be bent downwards or upwards to handle an offset in piping, but should not bend downward and then to the right or left. Bends create a torsional load on the hose. (See image page 66)
- Verify that the proper gasket or o-ring type seal is present and properly positioned before completing any screwed connection that has a straight mechanical thread, rather than tapered self sealing threads.
- Do not over pressure the hose or expose the hose to temperatures above or below the specified allowable limits. Maximum pressure and temperature limits are stamped on one ferrule of each hose for easy identification.
- The gaskets provided with Nexus UltraFlex™ hoses are made of EPDM material. This gasket is softer than traditional fiber gaskets to allow ease of installation and does not require extreme tightening to obtain a seal.

**Nexus Valve, Inc.**  
9982 E. 121<sup>st</sup> Street  
Fishers, IN 46037  
(888) 900-0947 (800) 900-8654 Fax  
info@nexusvalve.com www.nexusvalve.com

**Effective Date:** August 20, 2021

## ULTRAFLEX™

Care must be taken not to over tighten this connection. Over tightening can cause damage to the gasket and or sealing surfaces.

- When installing an UltraFlex™ gasket connection, care should be taken to verify that the gasket has been properly installed into the end of the hose. The metallic sealing surfaces on each side of this gasket should be visually examined to verify that they are flat and smooth with no sharp edges or deep scratches which could cut the gasket or provide a leak path beyond the gasket. The female nuts on each end of the hose have internal NPSH threads. This is a non-tapered thread identical to a standard tapered pipe thread, NPT, but without the taper.
- This threaded connection with gasket installed should be hand tightened and then further tightened no more than 1/4 revolution. No pipe dope or thread sealant should be applied to either sealing surface or pipe threads.



### UFH All Stainless Hoses

The UltraFlex™ 2 ½ UFH hose connector is designed specifically to compensate for pipe misalignment, absorb vibration and harmonics, and minimize stress on the piping system

**Nexus Valve, Inc.**  
 9982 E. 121<sup>st</sup> Street  
 Fishers, IN 46037  
 (888) 900-0947 (800) 900-8654 Fax  
 info@nexusvalve.com www.nexusvalve.com

**Effective Date:** August 20, 2021

## ULTRAFLEX™

### Installation Notes

- Do not compress the flexible connector to fit.
- Do not stretch the flexible connector to fit a gap larger than its factory furnished length.
- Do not force rotate ends of connector during assembly.
- Do not torque the end connectors.
- Anchor hose – an unsecured hose will transmit vibrations to the piping system.
- Do not bend hose sharply near fittings – fitting ends must always remain perpendicular to the axis of the hose.
- Do not let the hose support any weight except its own.
- Do not force hose into too much lateral offset.
- Do not bend hose less than 15” radius intermittent or 3” static.

### Gaskets on Hoses

- UFH (½” thru 1”) have captured gaskets on both sides (Fig. A).
- UFHF (½” thru 1”) have captured gasket on one side, and nothing provided on the opposite side, as the ¾” & 1-1/4” Fem fittings connect to a valve with o-ring (Fig. B).
- UFHM (½” thru 1”) have captured gasket on one side (Fig. C).
- UFHM (1-1/4” thru 2”) have supplied gasket on one side (i.e. not captured), (Fig. D).

**Fig. A**

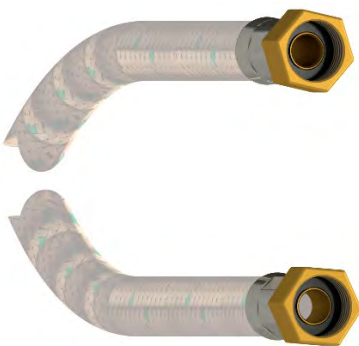

**Fig. B**

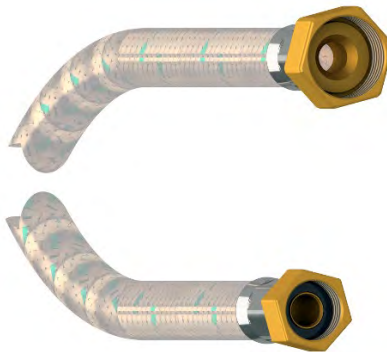

**Fig. C**

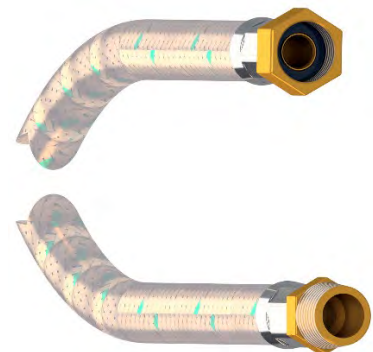

**Fig. D**

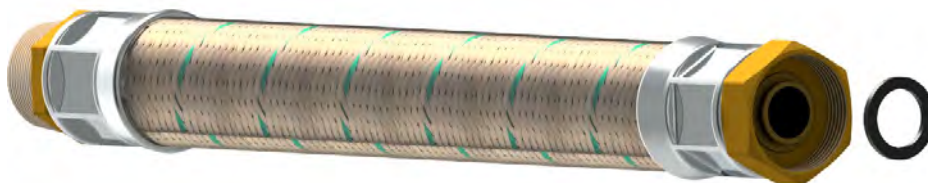

**Nexus Valve, Inc.**  
9982 E. 121<sup>st</sup> Street  
Fishers, IN 46037  
(888) 900-0947 (800) 900-8654 Fax  
info@nexusvalve.com www.nexusvalve.com

**Effective Date:** August 20, 2021

## METER KITS – MKA

### Meter Kits – MKA

The Meter Kit model MKA is a manually operated differential pressure metering kit for use with most automatic flow limiting valves.

#### Instructions

- Connect hoses to the testports—red high pressure hose upstream, blue low pressure hose downstream.
- Ensure the valves are open on the device being tested.
- Press the spring loaded “thumb” switch on clear valve, read, and record whether the pressure reading is high or low pressure from gauge.
- Release spring loaded “thumb” switch on clear valve, read, and record pressure reading from gauge.
- Subtract the low pressure reading from the high pressure reading to calculate differential pressure across the tested device.
- Drain the kit after use.
- The Model MKA test kit is equipped with filters near the end of the hoses. If the gauge responds slowly to changes in differential pressure, the filter elements may need to be cleaned. To remedy this, unscrew the two halves of the filter housing and remove the brass filter element. It may be cleaned by flushing with a mild detergent and water. After reassembly, if this has not satisfactorily improved the gauge performance, replace the filter element.
- Replace the caps on the test ports when you have completed using the metering kits.



Severe damage may occur if this test kit is subjected to freezing temperatures. Proper eye protection should always be worn when working with pressure containing parts. Some meter kits may have green colored hoses for low pressure in lieu of blue colored hoses.

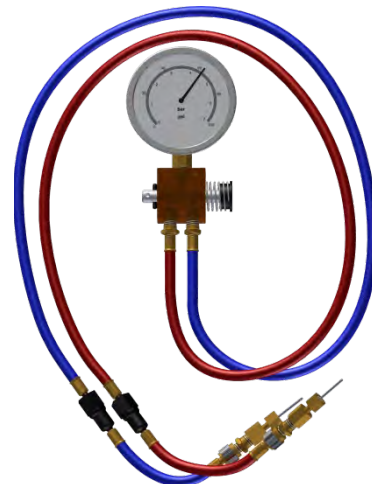
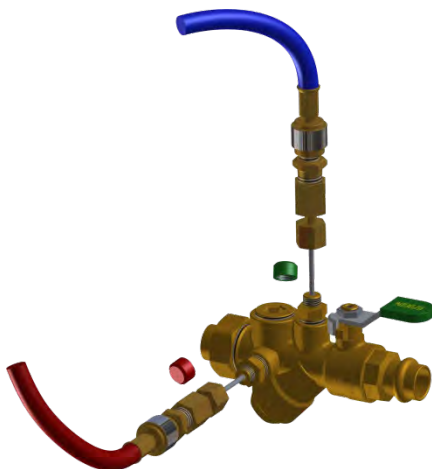

**Nexus Valve, Inc.**  
9982 E. 121<sup>st</sup> Street  
Fishers, IN 46037  
(888) 900-0947 (800) 900-8654 Fax  
info@nexusvalve.com www.nexusvalve.com

**Effective Date:** August 20, 2021

## METER KITS – MKM

### Meter Kits – MKM

The Meter Kit model(s) MKM are differential pressure meter kits designed for use with most types of balancing valves.

#### Instructions

- Connect hoses to the testports—red high pressure hose upstream, blue low pressure hose downstream.
- Ensure the valves are open on the device being tested and read differential pressure.
- Upon completion of test, disconnect hoses and store them in testkit case.
- Drain the kit after use.
- The Model MKM test kit is equipped with filters near the end of the hoses. If the gauge responds slowly to changes in differential pressure, the filter elements may be partially plugged and need to be cleaned. To remedy this, unscrew the two halves of the filter housing and remove the brass filter element. It may be cleaned by flushing with a mild detergent and water. After reassembly, if this has not satisfactorily improved the gauge performance, replace the filter element.
- Replace the caps on the test ports when you have completed using the metering kits.



Severe damage may occur if this test kit is subjected to freezing temperatures. Proper eye protection should always be worn when working with pressure containing parts. Some meter kits may have green colored hoses for low pressure in lieu of blue colored hoses.

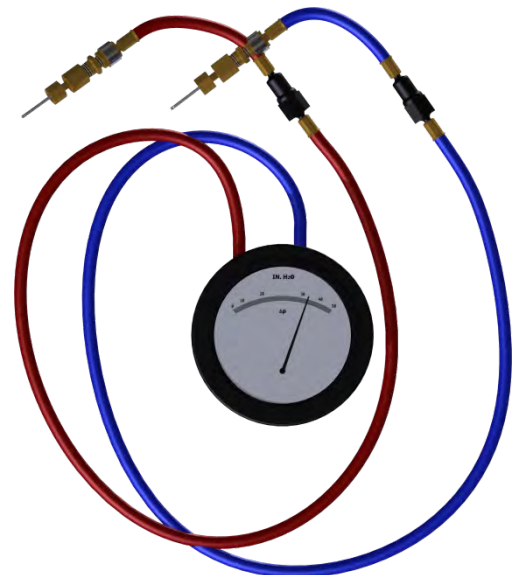
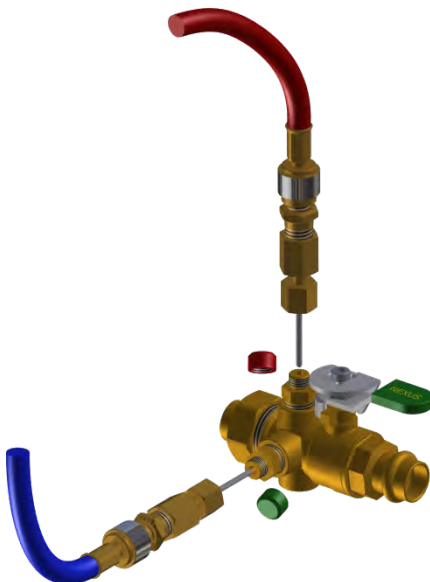

**Nexus Valve, Inc.**  
9982 E. 121<sup>st</sup> Street  
Fishers, IN 46037  
(888) 900-0947 (800) 900-8654 Fax  
info@nexusvalve.com www.nexusvalve.com

**Effective Date:** August 20, 2021

## MANUAL AIR VENTS

### Manual Air Vents

#### MV-025 & MV-025L

- MV's feature a blowout-proof actuating stem within a sturdy housing.
- MV-025 is slotted for quick and easy operation. To open, turn counter clockwise.
- MV-025L is equipped with a knurled thumbwheel. To open, turn counter clockwise.
- Ensure no debris is in seating area.
- Close vent when water begins to stream.



Do not over tighten when closing. Over tightening can damage the o-ring which may cause a leak. Hot liquid may be released when operating air vent.



Proper eye protection should always be worn when working with pressure containing parts.

**MV-025**



**MV-025L**





**Nexus Valve, Inc.**  
9982 E. 121<sup>st</sup> Street  
Fishers, IN 46037  
(888) 900-0947 (800) 900-8654 Fax  
info@nexusvalve.com www.nexusvalve.com

**Effective Date:** August 20, 2021

## HANDLE EXTENSION KITS

### Handle Extension Kits

Nexus Valve offers extension kits to extend handles above insulation. Extension kits are normally assembled to the valve at the factory. If field assembly is required, assemble as seen in image below. Not all valve handles include the memory stop feature.

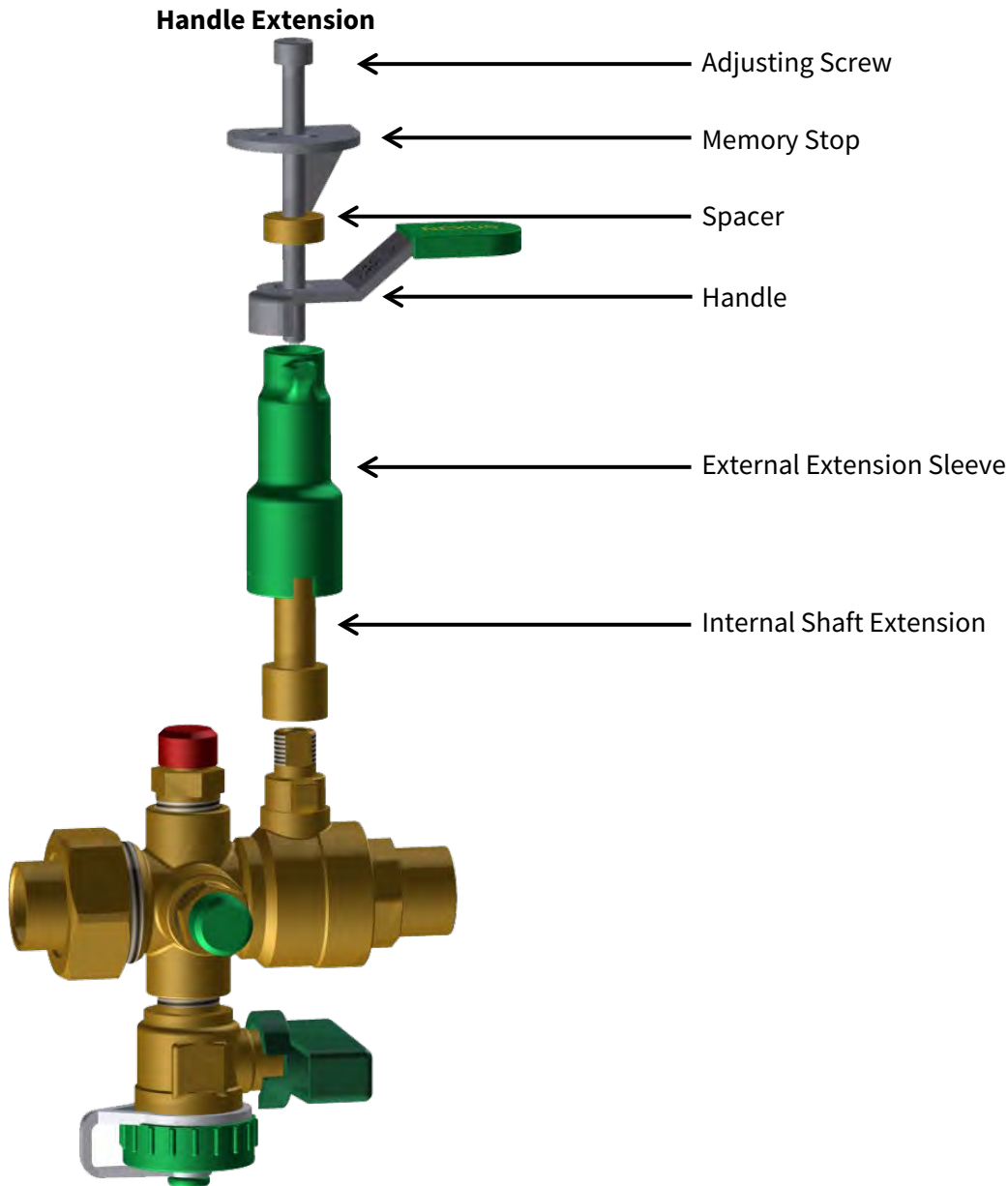

**Nexus Valve, Inc.**  
9982 E. 121<sup>st</sup> Street  
Fishers, IN 46037  
(888) 900-0947 (800) 900-8654 Fax  
info@nexusvalve.com www.nexusvalve.com

**Effective Date:** August 20, 2021

## EXTENSION PTE / PTEB

### Extension PTE / PTEB

#### Pre-Installation Inspection

- Visually verify that o-ring has been installed in PTE at the female threaded end and that the extension is not plugged with debris.
- Visually verify that male threads on the PTE have not been damaged and the end of the male threaded portion is satisfactory to act as a gasket surface.
- Carefully remove cap from pre-installed PT. Verify that no leakage is observed from the existing PT.



Caution: If seal in existing PT has been damaged the PT's cap may be under pressure and release hot liquid when the cap is removed.

Proper eye protection should always be worn when working with pressure containing parts.

#### Installation of PTE

- Screw the PTE onto the exposed male threads of the existing PT. Hand tightening is sufficient. (Over tightening may cause damage to the o-ring). Do not use a wrench to tighten the PTE.
- Hand tighten the cap removed from the PT on to the PTE extension to prevent dust and debris from accumulating on top of the internal seal of the PT. Note: The PTE is not intended to contain pressure.



It is not necessary to remove the PTE to take pressure or temperature readings through the PT as Nexus Valve offers extended probe needles for this purpose.



**Nexus Valve, Inc.**  
 9982 E. 121<sup>st</sup> Street  
 Fishers, IN 46037  
 (888) 900-0947 (800) 900-8654 Fax  
 info@nexusvalve.com www.nexusvalve.com

**Effective Date:** August 20, 2021

## UNION ADAPTER

### Union Adapter

#### General

Union adapters may be installed on a Nexus Valve brand valve or union with a 3/4" or 1/4" union size to adapt to the next union size to allow use of a larger union end connection. Refer to the chart below for applications. These adapters require the appropriate o-rings on each side of the adapter.

#### Model UA Installation Procedure

- Follow standard o-ring, tail piece, and union nut installation guidelines found on page 4.

#### Maintenance

- The Union Adapters do not require any annual or periodic maintenance.
- It is recommended to visually inspect products on regular intervals.

		UA 075 125	UA 125 200
<b>UltraMatic™</b>	UM	1/2"LO, 3/4"LO, 1"XLO	1/2"STD, 3/4"STD, 1"LO, 1-1/4"LO
<b>UltraMB™</b>	MB	1/2", 3/4LO, 1"LO	3/4"STD, 1"STD, 1-1/4"LO
<b>UltraY™</b>	UY	1/2", 3/4"LO, 1"LO	3/4"STD, 1"STD, 1-1/4"LO
<b>UltraX™</b>	UX	1/2", 3/4LO, 1"LO	3/4"STD, 1"STD, 1-1/4"LO
<b>UltraXB™ Orturi</b>	XB	1/2", 3/4LO, 1"LO	3/4"STD, 1"STD, 1-1/4"LO
<b>UltraU™</b>	UU	1/2"LO	1/2"STD, 3/4", 1"
<b>UltraNXP™</b>		1/2", 3/4"LO, 1"LO	3/4", 1", 1-1/4" LO
<b>NXU</b>		1/2"	3/4"
<b>O-rings</b>		OR-075, OR-125	OR-125, OR-200

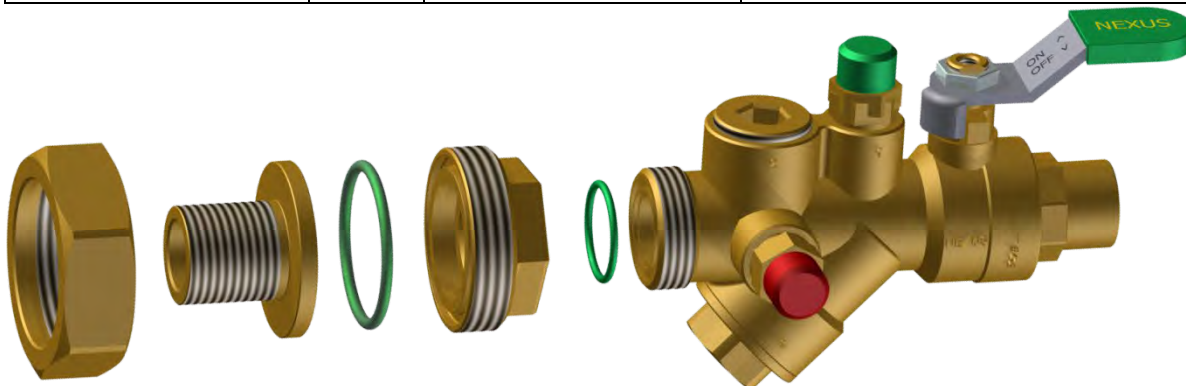

**Nexus Valve, Inc.**9982 E. 121<sup>st</sup> Street

Fishers, IN 46037

(888) 900-0947 (800) 900-8654 Fax

info@nexusvalve.com www.nexusvalve.com

**Effective Date:** August 20, 2021

---

---

**TOOL REQUIREMENTS**

---

---

**Tool Requirements**

<b>Item</b>	<b>Tooling Required For Installation</b>
PG-025	1/4" Hex Key (Allen Wrench)
PG-050	3/8" Hex Key (Allen Wrench)
PT-025	9/16" or 14mm Deep Socket
PT-050	7/8" Deep Socket
BD-025	7/8" Open End Wrench
BD-050	22 mm Open End Wrench
BD-075	Adjustable Wrench
MS-1	4 mm Hex Key (Allen Wrench)
MS-3	5 mm Hex Key (Allen Wrench)
MV-025	9/16" or 14mm Deep Socket
TP075-050M	9/16" Hex Key (Allen Wrench)
TP125-050M	9/16" Hex Key (Allen Wrench)
TP125-075M	3/4" Hex Key (Allen Wrench)
TP125-100M	7/8" Hex Key (Allen Wrench)
UN-075	(30 mm Hex nut) tighten by hand + 1/4 Turn with adjustable wrench
UN-125	(46 mm Hex nut) tighten by hand + 1/4 Turn with adjustable wrench
UN-200	(66 mm Hex nut) tighten by hand + 1/4 Turn with adjustable wrench
UN-250	(83 mm Hex nut) tighten by hand + 1/4 Turn with adjustable wrench



See pages 2 - 10 for recommend torque and tightening instructions.

**Nexus Valve, Inc.**  
9982 E. 121<sup>st</sup> Street  
Fishers, IN 46037  
(888) 900-0947 (800) 900-8654 Fax  
info@nexusvalve.com www.nexusvalve.com

**Effective Date:** August 20, 2021

---

---

**REPLACEMENT O-RINGS**

---

---

**Replacement O-Rings****OR-075****OR-125****OR-200****OR-200UX****OR-250**

**Sizes represent actual O-Ring diameter**

**Nexus Valve, Inc.**  
 9982 E. 121<sup>st</sup> Street  
 Fishers, IN 46037  
 (888) 900-0947 (800) 900-8654 Fax  
 info@nexusvalve.com www.nexusvalve.com

**Effective Date:** August 20, 2021

## REPLACEMENT GASKETS

### Replacement Gaskets

<b>150# Flange Ring Gasket (EPDM) P/N's &amp; Dimensions</b>				
<b>Nexus P/N</b>	<b>Flange Size</b>	<b>ID (in)</b>	<b>OD (in)</b>	<b>Thick (in)</b>
FG-250	2.50"	2-7/8	4-7/8	1/16
FG-300	3.00"	3-1/2	5-3/8	1/16
FG-400	4.00"	4-1/2	6-7/8	1/16
FG-500	5.00"	5-9/16	7-3/4	1/16
FG-600	6.00"	6-5/8	8-3/4	1/16
FG-800	8.00"	8-5/8	11	1/16
FG-1000	10.00"	10-3/4	13-3/8	1/16
FG-1200	12.00"	12-3/4	16-1/8	1/16

<b>Filter Cap Gasket (EPDM), Model SXF: P/Ns and Dimensions</b>				
<b>Nexus P/N</b>	<b>Strainer Size</b>	<b>ID (in)</b>	<b>OD (in)</b>	<b>Thick (in)</b>
SXFCGE-0250	2.50"	2.99	4.06	0.06
SXFCGE-0300	3.00"	3.62	4.69	0.06
SXFCGE-0400	4.00"	4.49	5.67	0.06
SXFCGE-0500	5.00"	5.71	6.69	0.06
SXFCGE-0600	6.00"	6.46	7.64	0.06



<b>Ultra-Flex Hose Gaskets</b>				
<b>Nexus P/N</b>	<b>Hose Size</b>	<b>ID (in)</b>	<b>OD (in)</b>	<b>Thick (in)</b>
UFHW-050*	0.50"	0.47	0.71	0.08
UFHW-075*	0.75"	0.67	0.91	0.08
UFHW-100*	1.00"	0.83	1.18	0.1
UFHW-125	1.25"	1	1.5	0.13
UFHW-150	1.50"	1.25	1.75	0.13
UFHW-200	2.00"	1.75	2.25	0.13

\*These gaskets intended only for use in 1/2", 3/4" or 1" female swivel ends of Nexus UltraFlex™ hoses which feature captive washer design.

<b>GASKETS for NAC/SAC INSTALLTIONS</b>				
<b>Nexus P/N</b>	<b>Cartridge Size</b>	<b>ID (in)</b>	<b>OD (in)</b>	<b>Thick (in)</b>
SAC-050-GASKET	0.50"	0.65	0.84	0.06
SAC-075-GASKET	0.75"	0.89	1.08	0.06
SAC-125-GASKET	1.25"	1.09	1.58	0.06
SAC-200-GASKET	2.00"	1.8	2.54	0.11
SAC-300-GASKET	3.00"	2.67	3.13	0.11



# Installation - Operation - Maintenance

---

**Nexus Valve, Inc.**  
9982 E. 121<sup>st</sup> Street  
Fishers, IN 46037  
(888) 900-0947 (800) 900-8654 Fax  
info@nexusvalve.com www.nexusvalve.com

**Effective Date:** August 20, 2021

---

## NOTES

---

### Notes