

*Robertshaw*<sup>®</sup>

# **RS10420T**

Installation Manual



The Robertshaw® Programmable WiFi Thermostat allows you to control the temperature anytime and anywhere. It features a large backlit display and LCD touchscreen for ease of operation. Compatible with any IOS or Android Smartphone.

## Thermostat System Types

Gas, Oil, or Electric Heat with Air Conditioning
Heat Pumps (without auxiliary or emergency heat)
Multi-Stage Systems
Heat-Only, including for Floor and Wall-Furnace
Cool-Only
750 Millivolt Heating Systems

## Power Options

Hardwire (Common Wire) only

### IMPORTANT SAFETY INFORMATION

#### WARNING:

- Always turn off power at the main power source by unscrewing fuse or switching circuit breaker to the off position before installing, removing, cleaning, or servicing thermostat.
- Read all of the information in this manual before installing or programming this thermostat.
- This is a 24V AC low voltage thermostat. Do not install on voltages higher than 30V AC.
- All wiring must conform to local and national building and electrical codes and ordinances.
- Do not short (jumper) across terminals on the gas valve or at the system control to test installation. This will damage the thermostat and void the warranty.

# INSTALLATION MANUAL

---

## Table of Contents

	<b>Page</b>
Installation Location	3-4
Thermostat Quick Reference	5
Wiring	6-7
Wiring Diagrams	8-10
Installer Setup	11-16
Programming	17-20
Setting Up WiFi Connection and App	21

## Specifications

---

Temperature Display Range .....	32°F to 99°F (0°C to 40°C)
Temperature Control Range .....	41°F to 90°F (5°C to 32°C)
Load Rating .....	1 amp per terminal, 1.5 amp maximum all terminals combined
Differential .....	Heating is adjustable from 0.2° to 2.0° Cooling is adjustable from 0.2° to 2.0°
Power Source .....	18 to 30 VAC, NEC Class II, 50/60 Hz for hardwire
Operating Ambient Temperature.....	32°F to +105°F (0°C to +41°C)
Operating Humidity .....	90% non-condensing maximum
Dimensions .....	4.7"W x 4.4"H x 1"D

## Wallplate Installation

1 Horizontal Mount

2 Vertical Mount

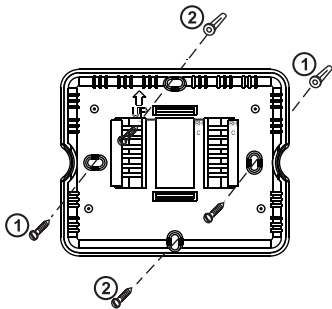

For a vertical mount, put screws on the top and bottom.

For a horizontal mount, put screws on the left and the right.

### **Caution:** **Electrical Hazard**

Disconnect power before installing this product. Failure to do so can cause electric shock or equipment damage.

### **Mercury Notice**

This product is mercury-free. However, if this product is replacing a control which contains mercury, it needs to be disposed of properly. Contact your local waste management authority for instructions regarding recycling and proper disposal of the control.

# INSTALLATION LOCATION

## Mounting Thermostat

Align the 4 tabs on the faceplate with the corresponding slots on the back of the thermostat, then push gently until the thermostat snaps into place.

Install the thermostat 4 to 5 feet above the floor in an area with good air circulation and average temperature.

For new installations, mount thermostat on an inside wall, 4-5 feet above the floor. Do not install the thermostat in the following locations:

- Behind a Door
- In a Corner
- Near Air Vents
- In Direct Sunlight
- With an Outside Wall Behind the Thermostat
- Near any Heat or Steam Generating Fixtures
- Near any Concealed Pipes or Chimneys

Installation at these locations will affect thermostat operation.

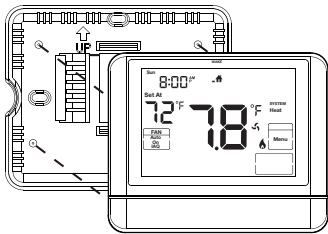

# THERMOSTAT QUICK REFERENCE

## Getting to know your thermostat

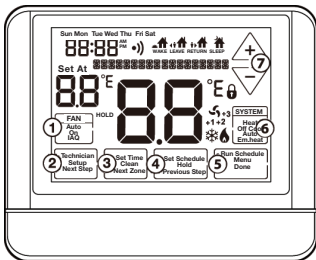

- 1 Fan Buttons
- 2 Next Step Buttons
- 3 Set Time Buttons
- 4 Program Buttons
- 5 Menu Buttons
- 6 System Buttons
- 7 Set-Point Buttons

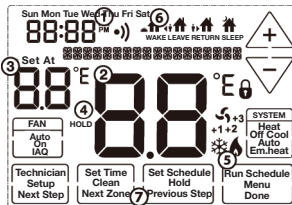

- 1 Days of the week and time
- 2 Indicates the current room temperature
- 3 Displays the user selected set-point temperature
- 4 Hold is displayed when thermostat program is overridden.
- 5 **System Operation Indicators:** If these icons are flashing, there is a 5-minute delay for compressor protection.
- 6 **Programmable Time Periods:** Residential uses 4 time periods - **WAKE, RETURN, LEAVE** and **SLEEP**.
- 7 **Program Menu Options:** Shows different options during programming.

# WIRING

## Terminal Designations

		Y1	Y2	W/E	W2	0	B
CONVENTIONAL HVAC		COOL MODE STAGE 1	COOL MODE STAGE 2	HEAT MODE STAGE 1	HEAT MODE STAGE 2	-	-
HEAT PUMP	1H / 1C	HEAT 1 COOL 1				HEAT PUMP REVERSING VALVE - ENERGIZED DURING COOLING	HEAT PUMP REVERSING VALVE - ENERGIZED DURING HEATING
	2H / 1C			AUX 1	HEAT 2 AUX 2		
	3H / 1C			HEAT 2 AUX 1	HEAT 3 AUX 2		
	2H / 2C		HEAT 2 COOL 2				
	3H / 2C		HEAT 2 COOL 2	AUX 1	HEAT 3 AUX 2		
	4H / 2C		HEAT 2 COOL 2	HEAT 3 EMHEAT	HEAT 4 EMHEAT		



### Installation Tip

Do not overtighten terminal block screws, as this can damage the terminal block. A damaged terminal block can keep the thermostat from fitting on the subbase correctly or cause system operation issues.

**Max Torque = 6in/lbs.**



## Notes

---

### Wire Specifications

Use 18- to 22-gauge thermostat wire. Shielded wire is not required.

### Emergency Heat Operation:

In many heat pump systems with no emergency heat relay, a jumper can be installed between **E** and **W2** to turn thermostat into a single stage control for Emergency Heat Operation.

### Float Switches:

A float switch or similar device which breaks the control wire (Y) not the power (R) should be installed. Interrupting the power circuit will shut off the power to the thermostat completely and stop it from operating.

# WIRING DIAGRAMS

- 1 Power supply
- 2 Factory-installed jumper. Remove only when installing on 2-transformer systems
- 3 Use either O or B terminals for reversing valve
- 4 24 VAC common connection

## Typical 2H/2C System: 1 Transformer

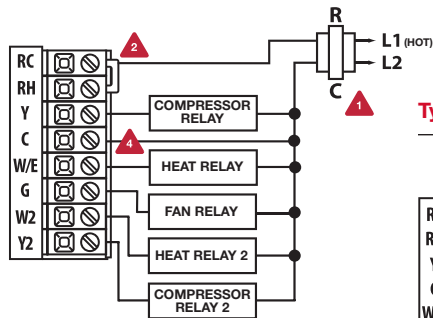

## Typical Cool-Only System With Fan

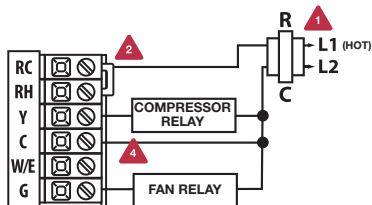

## Typical Heat Only System With Fan

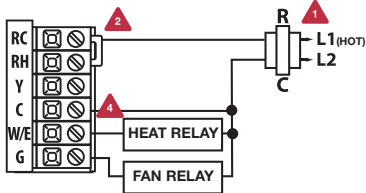

## Note:

In many systems with no emergency heat relay, a jumper can be installed between E and W2.

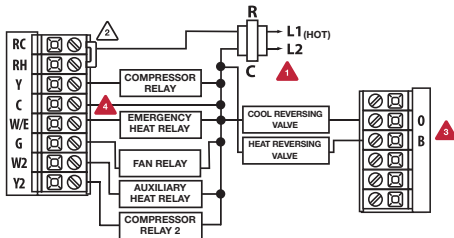

# WIRING DIAGRAMS

## Typical 3H/2C or 2H/1C Heat Pump System

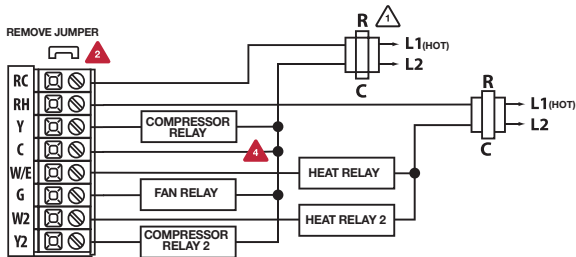

## Typical 2H/2C System: 2 Transformers









1. Press **MENU**.
2. Press and hold **TECHNICIAN SETUP** for 3 seconds.
3. Configure the installer options as desired using the table below.
4. Use  or  to change settings and the **NEW STEP** or **PREV STEP** to move from one step to another. Note: Only press **DONE** when you want to exit the Installer Setup options.





Settings		Display	Adjustment Options	Default
Setup WiFi	WiFi router parameter configuration	WIRELESS SETUP		
Filter Change Reminder	This setting will flash <b>FILT</b> in the display after the elapsed run time to remind the user to change the filter. The <b>OFF</b> setting will disable this feature.	FILTER OFF  SE	The filter change reminder can be adjusted from <b>OFF</b> to 2000 hours in 50 hour increments. Press the second button from the top left side of the thermostat to display the current filter elapsed run time.	<b>OFF</b>
Room Temperature Calibration	This setting allows the installer to change the calibration of the room temperature display so that, for example, the thermostat would read 74°F instead of 70°F.	CALIBRATE  0°F	The room temperature display can be adjusted to read 4° above or below the factory calibrated temperature.	<b>0</b>

# INSTALLER SETUP

Settings		Display	Adjustment Options	Default
Minimum Compressor On-Time	The installer can select the minimum run time for the compressor to help protect the compressor from short-cycling.	MIN COMP OF	The minimum compressor run time can be adjusted from <b>OFF</b> to 3, 4, or 5 minutes. If 3, 4, or 5 is selected, the compressor will run for at least the selected time before turning off (although the fan may continue to run for a short time).	<b>OFF</b>
Compressor Short Cycle Delay	The compressor short cycle delay setting will not allow the compressor to be turned on for 5 minutes after it was last turned off in order to protect the compressor.	COMP PROTECTS ON	The compressor short cycle delay setting can be removed by selecting <b>OFF</b> .	<b>ON</b>
Cooling Differential	The cooling differential is factory preset at 0.5°. This means that whenever the room temperature heats by 0.5° full degree from the temperature setting, the cooling system will turn on. If the cooling system turns on too often, increase the temperature differential.	COOL SWING 0.5°F	The cooling differential setting is adjustable from 0.2°F to 2°F.	<b>0.5</b>







Settings	Display	Adjustment Options	Default
<p>Heating Differential</p> <p>The heating differential is factory preset at 0.4°. This means that whenever the room temperature cools by 0.4° from the temperature setting, the heating system will turn on. If the heating system turns on too often, increase the temperature differential.</p>	<p>HEAT SWING</p> <p>0.4°F</p>	<p>The heating differential setting is adjustable from 0.2°F to 2°F.</p>	<p>0.4</p>
<p>Heat Pump</p> <p>The thermostat can be optionally configured to operate a heat pump.</p>	<p>HEAT PUMP</p> <p>OF</p>	<p>Use  or  to configure the setting. <b>OFF</b> for conventional systems and <b>ON</b> for heat pump systems.</p>	<p>OFF</p>
<p>System Switch</p> <p>The system switch can be configured for the particular application. Heat - Off - Cool, Heat - Off, Cool - Off, Heat - Off - Cool - Auto. Note: Emergency Heat is available in heat pump mode only.</p>	<p>SYSTEM SET</p> 	<p>Use  or  until the desired application is flashing. <b>AUTO</b> = (Auto Changeover)</p>	<p>OFF</p>
<p>Stages of Heat and Cool</p> <p>If the heat pump is still <b>ON</b>, this thermostat can be configured to operate up to 2H/2C conventional, or up to 4H/2C heat pump system.</p>	<p>2H2C</p> <p>STRGS OF HEAT • COOL</p>	<p>Use  or  to select stages of heat, press <b>NEXT</b>, then select stages of cool. 3 or 4 heat will use Y1 and Y2 as 1st and 2nd stage of heat.</p>	<p>2 STAGES</p>

# INSTALLER SETUP

Settings		Display	Adjustment Options	Default
Cooling Fan Delay	The cooling fan delay setting delays the fan from coming on in cool mode and keeps it running after the compressor shuts off for a short time in order to save energy.	COOL FAN DELAY  OF	The cooling fan delay can be set to <b>OFF</b> , 15, 30, 60 or 90 seconds. If 15, 30, 60 or 90 is selected, the fan will not turn on for at least the selected time when there is a call for cool and will run for at least the selected time after satisfying the call for cool.	<b>OFF</b>
Heating Temperature Set-Point Limit	This setting establishes a maximum value above which the set-point temperature value cannot be raised.	HEAT LIMIT  90°F	Use  or  to select the maximum heat temperature set-point. The maximum heat temperature set-point is 90°F. Range 44°F - 90°F	<b>90°</b>
Cooling Temperature Set-Point Limit	This setting establishes a maximum value above which the set-point temperature value cannot be lowered.	COOL LIMIT  44°F	Use  or  to select the maximum cool temperature set-point. The minimum cool temperature set-point is 44°F. Range 44°F - 90°F	<b>44°</b>
F° or C°	Select F for Fahrenheit temperature display or select C for Celsius display.	OF OR C SET  83°F	°F for Fahrenheit °C for Celsius	<b>F°</b>



# INSTALLER SETUP

Settings		Display	Adjustment Options	Default
12 or 24 Hour Clock	Select a 12 or 24 hour clock setting.	12 H	Use  or  to select 12 or 24 hour clock.	12 Hour Clock
Fan Operation	Select <b>GAS</b> or <b>ELEC</b> depending on the type of furnace.	GAS FAN OPERATION	<b>GAS</b> or <b>ELEC</b>	<b>GAS</b>
Morning Recovery	This setting will start heating early to bring the building temperature to its programmed set-point by the beginning of the <b>WAKE</b> time period.	MORNING RECOVERY  ON	Use  or  to turn ON or OFF.	ON
Display Light	The display light can be configured to come on when any key is pressed or to stay on all of the time.	AUTO  DL	<b>AUTO</b> - Any key ON <b>ON</b> - Always ON	<b>AUTO</b>
Contractor Call Number	The thermostat allows installers to put their phone number in the display.	PHONE NUM  OF	If selected <b>ON</b> , the input screen will appear after pressing <b>NEXT STEP</b> . Use  or  key to select the desired telephone number and the <b>FAN</b> or <b>SYSTEM</b> key to change characters.	<b>OFF</b>

# INSTALLER SETUP

Settings		Display	Adjustment Options	Default
Beep	The thermostat can be configured to make an audible beep when any key is pressed.	BEEP OF	If <b>ON</b> is selected, the beep will sound. If <b>OFF</b> is selected, the beep will be silenced.	ON
MACID	This step shows the MAC address of WiFi module.	MACID 980863079022		
Firmware Version	This step shows the version of firmware that is installed on the thermostat.	FIRMWARE VER 0100	Press <b>NEXT</b> to move to next step. Press <b>DONE</b> to exit. Press and hold <b>TECH</b> to enter <b>ADVANCED TECH STEPS</b> .	
Factory Default Reset	This step resets all WiFi settings to factory default.	NO DEFAULT	Press <b>YES</b> to reset.	

## Programming Notes

---

### Differential Setting

The second stage will turn **ON** at 2x the differential setting and **OFF** at 1x the differential setting. For example, if the differential setting is 0.5° for heating and the thermostat is set at 70°F, the first stage will turn on at 69.5°F. The second stage will turn on at 69°F and turn off at 69.5°F. If the third stage is used, the third stage will turn on at 68.5°F and turn off at 69°F.

### Keypad Lockout

The installer can activate a keypad lockout after exiting Tech Setup.

### Auto Changeover

In Auto mode, users can toggle between Auto Heat or Auto Cool by pressing **System** only when the current mode has reached its temperature set point. To switch out of Auto mode, hold down **System**. To return to Auto mode, toggle the System key to **Auto**.

### Reminders

Once a Reminder has been turned on and set, the elapsed time can be checked by navigating the Tech Setup step. The time can be reset by pressing and holding the third button from the left for 3 seconds. Resetting an expired Reminder can be done by pressing and holding the 3rd button from the left for 3 seconds.

### Contractor Call Number







If contractor call number is selected **ON**, the selected phone number will show in the display if there has been a continuous call for heating or cooling for 24 hours or if the **FAN** button is held down for 3 seconds. To remove the phone number from the display, hold the **FAN** button down for 3 seconds.





## PROGRAMMING

---

### Set Time of day and day of the week (If using programming)

---

1. Press the **MENU** button.
2. Press **SET TIME**.
3. Day of the week will be flashing. Use  or  to select the current day of the week.
4. Press **NEXT**.
5. The current hour will be flashing. Use  or  to select the current hour. Note the correct a.m. or p.m. indicator is selected.
6. Press **NEXT**.
7. The minutes will be flashing. Use  or  to select current minutes.
8. Press **DONE** when completed.

1. Select **HEAT** or **COOL** using the system key.  
**Note:** Heat and cool need to be programmed separately.
2. Press **MENU** (If menu does not appear first, press **RUN SCHED**).
3. Press **SET SCHED**. **Note:** Monday will be displayed and the **WAKE** icon is shown.
4. Time will be flashing. Use  or  to make your time selection for that day's **WAKE** time period. **Note:** If you want the fan to run continuously during this time period, select **ON** with the **FAN** key.
5. Press **NEXT STEP**.
6. The set-point temperature will be flashing. Use  or  to make your set-point selection for the **WAKE** time period for Monday–Friday (or Monday if in 7 Day mode).
7. Press **NEXT STEP**.
8. Repeat steps 4 through 7 for the **LEAVE** time period, for the **RETURN** time period, and for the **SLEEP** time period for Monday–Friday (or Monday if in 7 Day mode).

























**Tuesday, Wednesday, Thursday, Friday, Saturday, Sunday**

Repeat steps 4 thru 7 for the remaining days of the week.

# PROGRAMMING

## Default Program

This thermostat is pre-programmed for energy saving operation. The default program is below:

Default Program				
Day of the Week	Events	Time	Set-Point Temperature (Heat)	Set-Point Temperature (Cool)
Weekday	Wake  	6 a.m.	70°F (21°C)	75°F (24°C)
	Leave  	8 a.m.	62°F (17°C)	83°F (28°C)
	Return  	6 p.m.	70°F (21°C)	75°F (24°C)
	Sleep  	10 p.m.	62°F (17°C)	78°F (26°C)
Saturday	Wake  	8 a.m.	70°F (21°C)	75°F (24°C)
	Leave  	10 a.m.	62°F (17°C)	83°F (28°C)
	Return  	6 p.m.	70°F (21°C)	75°F (24°C)
	Sleep  	11 p.m.	62°F (17°C)	78°F (26°C)
Sunday	Wake  	8 a.m.	70°F (21°C)	75°F (24°C)
	Leave  	10 a.m.	62°F (17°C)	83°F (28°C)
	Return  	6 p.m.	70°F (21°C)	75°F (24°C)
	Sleep  	11 p.m.	62°F (17°C)	78°F (26°C)

## SETTING UP WIFI CONNECTION AND APP

The Robertshaw RS10420T Programmable WiFi Thermostat works with the Robertshaw Thermostat App which is available for IOS and Android platforms. Users can download the App from the Apple store or Google Play.

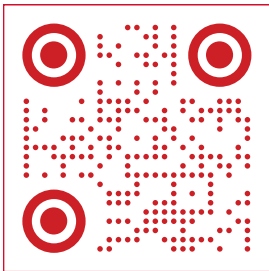

Use Phone to Scan for App  
Installation Instructions





Customer Service +1.800.304.6563  
Technical Service +1.800.445.8299  
HVACCustomerService@robertshaw.com  
www.robertshaw.com • 352-00308-001 Rev. B

© 2021 Robertshaw Controls Company.  
Robertshaw® is a trademark of Robertshaw Controls Company.

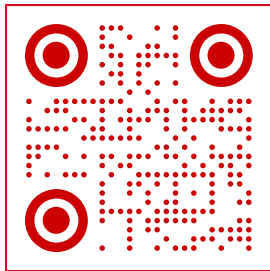

**6** Year  
Limited  
Warranty

Use Phone  
to Scan for  
Warranty Info